

# Operating Instructions

## C-VLU 301

Vacuum pump

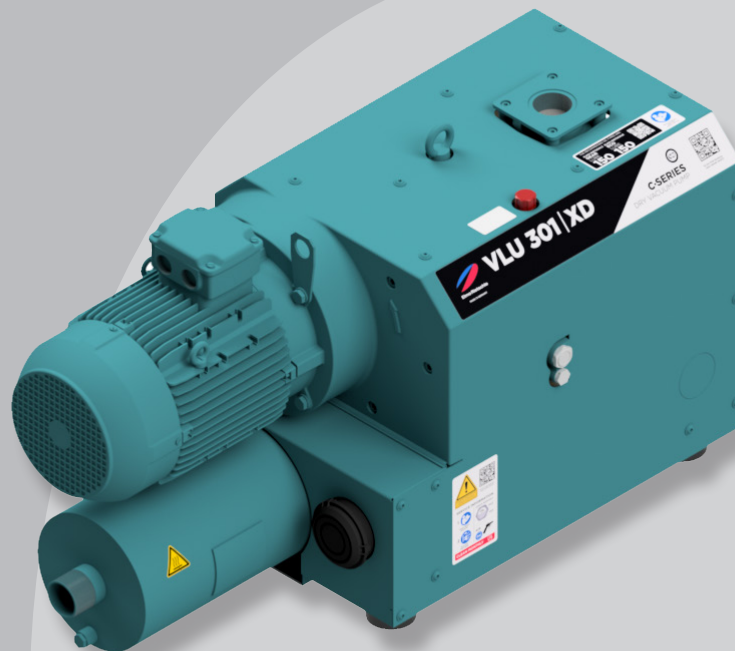

C-Serie  
C-Series

Klaue  
Claw



Table of contents

<b>1</b>	<b>Foreword</b> .....	<b>4</b>
1.1	Principles .....	4
1.2	Target group .....	4
1.3	Supplier documentation and accompanying documents .....	4
1.4	Directives, standards, laws .....	4
1.5	Copyright .....	4
1.6	Disclaimer .....	5
1.7	Specialist terms and meaning .....	5
<b>2</b>	<b>Safety</b> .....	<b>6</b>
2.1	General .....	6
2.2	Labelling of warnings .....	6
2.3	Symbols and meaning .....	6
2.4	Intended use .....	8
2.5	Inadmissible operating modes .....	8
2.6	Personnel qualification and training .....	8
2.7	Personal protective equipment .....	9
2.8	Safety-conscious working .....	9
2.9	Responsibilities of the user .....	10
2.10	Hazardous substances .....	10
	2.10.1 Conveying media .....	10
	2.10.2 Auxiliary materials and lubricant .....	10
2.11	Safety equipment, monitored functions .....	11
2.12	Emergency Stop / Emergency Off .....	11
2.13	Protection of environment .....	11
<b>3</b>	<b>Transport and storage</b> .....	<b>12</b>
3.1	Transport .....	12
	3.1.1 Unpack and check the as-delivered condition .....	12
	3.1.2 Lift and transport .....	12
3.2	Storage .....	13
	3.2.1 Ambient conditions during storage .....	13
<b>4</b>	<b>Product overview and functioning</b> .....	<b>14</b>
4.1	Product Overview C-VLU 301 .....	14
4.2	Data plate .....	15
4.3	Description .....	15
4.4	Fields of application .....	16
4.5	Accessories .....	16
	4.5.1 Intake filter .....	16
<b>5</b>	<b>Installation</b> .....	<b>17</b>
5.1	Preparation of installation .....	17
5.2	Installation .....	17
5.3	Connection of pipes .....	18
5.4	Check lubricating oil .....	18
5.5	Connect to the energy supply network .....	19
	5.5.1 Connection of motor .....	19
5.6	Connect pressure monitoring .....	20

<b>6</b>	<b>Commissioning and decommissioning</b>	<b>21</b>
6.1	Start-up	21
6.1.1	Installation check	21
6.1.2	Check the rotation direction	22
6.2	Operation	22
6.2.1	Discharge condensate	22
6.3	Decommissioning	23
6.3.1	Decommissioning of the machine	23
6.3.2	Storing the machine	23
6.4	Recommissioning	23
<b>7</b>	<b>Maintenance and repair</b>	<b>24</b>
7.1	Ensure operational safety	24
7.2	Maintenance table	25
7.3	Preparing maintenance works	25
7.4	Clean vacuum pump	25
7.5	Lubricating Oil	26
7.5.1	Check/refill oil level	26
7.5.2	Oil change	27
7.6	Air filter	27
7.6.1	Mesh filter	28
7.6.2	Filter silencer	28
7.6.3	Intake filter (accessories)	29
7.7	Motor and coupling	29
7.7.1	Motor	29
7.7.2	Coupling	29
7.8	Repair / service	30
7.9	Spare parts	31
<b>8</b>	<b>Errors</b>	<b>32</b>
<b>9</b>	<b>Disassembly and disposal</b>	<b>33</b>
9.1	Disassembly	33
9.2	Disposal	33
<b>10</b>	<b>Technical Data</b>	<b>34</b>

# 1 Foreword

## 1.1 Principles

These Operating Instructions:

- form a part of the following contact-free running claw vacuum pumps C-VLU 301.
- Describe how to use these pumps safely and properly in all life phases and are true for all responsible persons
- Include general information on installation, commissioning, maintenance and inspection
- Must be available at the place of application.

Figures presented in these Operating Instructions serve for better understanding and can deviate from the components installed. This does not influence the validity of the details set out in the instructions.

## 1.2 Target group

Target group for these Operating Instructions are the technically trained specialist personnel which have been qualified by appropriate training and instruction.

## 1.3 Supplier documentation and accompanying documents

Document	Contents	No.
Supplier documentation	Operating Instructions	BA 892
	Declaration of Conformity	C0113
	Declaration of no-objection	7.7025.003.17
Spare parts list	Spare parts documents	E 892
Data sheet	Technical data and characteristic curves	D 892
Info sheet	Storage guideline for lubricants	I 100
Info sheet	Storage guideline for machines	I 150

The documents can be ordered from our Service or downloaded using the following link:

- <http://www.elmorietschle.com>

## 1.4 Directives, standards, laws

See Declaration of Conformity.

## 1.5 Copyright

These Operating Instructions are intended for the customer's internal purposes.

Unless expressly permitted, passing on to third parties, copying of these documents, except for internal purposes, as well as using and providing their contents to third parties, even in excerpts, is prohibited.

Contraventions will lead to claims for damages.

## 1.6 Disclaimer

Please note that we cannot accept any liability for damages arising from failure to observe the instructions. Gardner Denver Schopfheim GmbH does not assume liability for the following cases:

- Not intended use
- Not complying with these instructions
- Nonobservance of all documents and specifications belonging to the overall documentation
- Erection, operation, maintenance and repair by insufficiently qualified staff
- Modification or removing of the part or serial number
- Using spare parts that have not been approved by **Gardner Denver Schopfheim GmbH**
- Unauthorised modifications to the machine or the accessories supplied by **Gardner Denver Schopfheim GmbH**

Please, also consider that repairs are only allowed to be done by authorised workshops using original spare parts; otherwise our guarantee will expire.

## 1.7 Specialist terms and meaning

Term	Explanation
Machine	Pump and motor combination ready for connection
Motor	Pump drive motor
Vacuum pump	Machine for creating underpressure (vacuum)
Claw	Design or operating principle of the machine
Suction capacity	Vacuum pump, volumetric flow related to the condition in the inlet connection, specified in m <sup>3</sup> /h
Final pressure (abs.)	The maximum vacuum that a pump reaches while the inlet opening is closed, displayed as absolute pressure in mbar (abs.)
Permanent vacuum	Vacuum or the inlet pressure range, at which the pump operates in continuous operation. The permanent vacuum or inlet pressure is $\geq$ than the final vacuum and $<$ than the atmospheric pressure.
Noise emission	Noise emitted at a specific loading state indicated as a numeric value, sound pressure level dB(A) as per EN ISO 3744.

Abbreviation	Meaning
Fig.	Figure
Tab.	Table
C-VLU	Model description of the vacuum pump
CD	Machine in standard version
XD	Pump with corrosion-protective coating

## 2 Safety

The manufacturer is not responsible for damage due to non-observance of the whole documentation.

### 2.1 General

These operating instructions contain basic instructions for installation, commissioning, maintenance and inspection work which must be obeyed to ensure the safe operation of the machine and prevent physical and material damage.

Observe the safety instructions in all chapters.



The operating instructions must be read by the responsible technical personnel / user before installing and commissioning and must be fully understood. The contents of the operating instructions must always be available on site for the technical personnel/user. Instructions attached directly to the machine must be obeyed and must always remain legible. For example, this applies:

- Symbols for connections
- Data plate and motor data plate
- Information signs and warning plates



The data plates on the vacuum pump may not be removed, even if the machine is resold. For all queries about the product, please always quote the serial number.





The user is responsible for observing local regulations.

### 2.2 Labelling of warnings

Warning	Danger level
 <b>DANGER</b>	...warns of a hazardous situation, which will lead to death or life-threatening injuries if not avoided.
 <b>WARNING</b>	...warns of a potentially dangerous situation, which can lead to death or serious injuries if not avoided.
 <b>CAUTION</b>	...warns of a hazardous situation, which can cause slight or medium personal injuries if not avoided.
<b>NOTICE</b>	...warns of a situation that can cause damages to or destruction of material assets if not avoided.

### 2.3 Symbols and meaning

Symbol	Explanation
	Instructions, action
a), b),...	Instructions in several steps
	Results
	Reference

Symbol	Explanation
<p>Warning signs</p> 	<p>Obey all safety instructions with this symbol in order to avoid injury or death.</p> <p>Warns of potential risk of injury</p> <p>Warns of electrical voltage</p> <p>Warns of suspended loads</p> <p>Warns of hot surface</p>
<p>Mandatory signs</p> 	<p>Obey all instructions with this symbol in order to avoid injury or death.</p> <p>Observe the Operating Instructions</p> <p>Wear eye protection</p> <p>Wear protective gloves</p> <p>Wear safety shoes</p> <p>Wear ear protection</p> <p>Disconnect the plant and secure it against unexpected restart</p>
	<p>Information, note</p>
	<p>Protection of environment</p>

### 2.4 Intended use

The machine is suitable for conveying the following media:

- Standard model:  
all non-explosive, non-flammable, non-aggressive, non-toxic, dry gases and gas-air mixtures
- XD model:  
all non-explosive, non-flammable, non-aggressive, non-toxic, moist gases and gas-air mixtures

The machine must only be operated in such areas as are described in the operating instructions:

- Only operate the machine in technically perfect condition
- The machine must only be operated at an ambient temperature and inlet temperature of between 5 and 40 °C  
Please contact us for temperatures outside this range
- The permissible back pressure may not be exceeded  
Maximum permissible back pressure: + 30 mbar
- The machine is only allowed to be operated with the following safety-relevant accessories installed:  
Pressure monitoring on inlet side (e.g. pressure switch).

Any use extending beyond this use is seen as not in accordance with the intended use.

The intended use also includes the compliance with the operating data and operating agents specified in the operating instructions, the listed maintenance works, as well as the details in the documentation issued by the manufacturers of components and attachments.

If used under critical conditions and/or in case of any doubts, please contact the manufacturer. Non-observance can cause machine failures.

### 2.5 Inadmissible operating modes

- Extracting, conveying and compressing of explosive, inflammable, aggressive or poisonous media, e.g. dust as per ATEX zone 20-22, solvents as well as gaseous oxygen and other oxidation agents, water vapour, water vapour (does not apply to the XD model), liquids or solids
- Erection and operation in potentially explosive environment (explosive gas/vapour/mist-air mixtures or dust-air mixtures or hybrid mixtures of air and flammable substances)
- Using the machine in non-commercial plants unless the necessary precautions and protective measures are taken in the plant
- Operation of the machine when it is only partially assembled
- Operation without cover sheet
- Using the machine in areas with ionising radiation
- Back pressures on the outlet side: > +30 mbar
- Modifications to machine and accessories
- Operation by not or not sufficiently qualified personnel

### 2.6 Personnel qualification and training

All works are only allowed to be done by qualified and trained specialist personnel of legal age. Unauthorised persons are not allowed to stay within the operating area and must be prevented from entering operating rooms by suitable measures.

- Ensure that people entrusted with working on the machine have read and understood these operating instructions before starting work, particularly the safety instructions for installation, commissioning, maintenance and inspection work
- Responsibilities, competences and monitoring of personnel must be regulated by the operating company.



- The following works are only allowed to be done by technical specialist personnel, who have been trained and instructed for the works assigned:
  - Transport only by forwarding agents
  - Erection, commissioning, maintenance and inspection works, as well as troubleshooting by technical specialist personnel (e.g. locksmith, mechanics)
  - Works on the electrical system are only allowed to be done by electricians
- Personnel to be trained and laypersons may only carry out work on the machine when under the supervision of authorised specialist personnel and must be instructed about possible hazards in a safety instruction.

**Specialist personnel:**

Persons that can evaluate work assigned to them and evaluate possible risks as a result of their training, knowledge and experience as well as the applicable regulations.

**Qualified electrician:**

Specialist personnel that has obtained an electrotechnical specialist education and is familiar with work for setting up, operation and maintenance of electrical systems and operating material.

**Unauthorised persons:**

Unauthorised persons are persons who cannot appropriately prove that they are qualified, trained, or instructed for the works on the compressor. In addition, those persons shall be seen as unauthorised who, due to their physical, cognitive, and health abilities, are not able to recognise hazards caused by the vacuum pump.

**2.7 Personal protective equipment**

The user must make sure that the required protective clothing and protective equipment is available on the plant and used by the personnel. The national legal provisions and the national regulations for industrial safety must be observed.

Recommended protective equipment:



Wear eye protection



Wear protective gloves



Wear safety shoes



Wear ear protection

**2.8 Safety-conscious working**

The following safety regulations apply in addition to the safety instructions and intended use listed in these instructions:

- Accident prevention regulations, safety and operating regulations
- Standards and laws in force
- Hot parts of the machine must not be accessible during operation or must be fitted with a guard
- Persons must not be endangered by the free extraction or discharge of pumped media
- Risks arising from electrical energy must be eliminated
- The machine must not come into contact with flammable materials.  
Risk of fire due to hot surfaces, output of hot pumped media or cooling air

### 2.9 Responsibilities of the user

During the whole operating period of the machine, the operating company is obliged to prove that the limits have been met and the required maintenance and inspection works have been performed.

The user must ensure that:

- All works for installation, commissioning and maintenance are carried out by authorised and qualified specialist personnel, who gained enough information by an in-depth study of the operating instructions
- All works on electrical equipment are done by an electrician in compliance with the regulations for electrical installations
- The Operating Instructions are always available at the site of operation of the machine for the whole life phase
- All safety instructions and signs on the vacuum pump are always complete and legible
- The operating and maintenance personnel take note of all safety instructions - especially of information provided in these Operating Instructions - and observe them
- The personal protective equipment is available and is used by the personnel
- All safety-relevant regulations are met
- Unauthorised persons cannot enter the operating site
- Fire warning and firefighting possibilities have been installed and are active
- These Operating Instructions shall be amended by working instructions, as well as the duties to supervise and report. With this they shall consider the operational distinctions. Among others, it refers to instructions referring to:
  - Organization of work
  - Work procedures
  - Specialist personnel assigned

In the event of accidents caused by the vacuum pump notify the Gardner Denver Schopfheim GmbH. Please find contact data on the back page.

### 2.10 Hazardous substances

#### 2.10.1 Conveying media

Machinery that may have contact to hazardous substances can cause serious burns, cauterisation or poisoning during disassembly, maintenance and repair work.

- Each time before using our services, it is necessary for reasons of occupational safety and environmental protection to indicate and declare hazardous substances on or in the plant.
- Send the completed and signed declaration of no objection back to Gardner Denver Schopfheim. If no declaration has been sent, we must assume that the plant is free from such substances. In case of doubt, our service department reserves the right to reject the acceptance until the safety has been determined without doubt.

#### 2.10.2 Auxiliary materials and lubricant

Incorrect auxiliary materials and lubricants may decompose at high temperatures. The resulting vapours may be harmful to health and cause fires.

- Use exclusively the recommended auxiliary materials and lubricants
- Observe the oil recommendation sign on the machine
- Observe the safety data sheets of the substances used
- Ensure proper use
- Observe the maintenance intervals

## 2.11 Safety equipment, monitored functions

Missing or non-functional safety equipment may lead to dangerous operating states and thus result in life-threatening injuries.

- Do not modify or bypass safety equipment and safety functions
- Check the function at regular intervals

## 2.12 Emergency Stop / Emergency Off



**Danger to life if the electrical installation has not been carried out professionally!**

Missing safety equipment may lead to hazardous operating conditions. This can result in severe to mortal injury.

- The vacuum pump does not have its own Emergency Stop or Emergency Off. This must be implemented by the operator, for example, by integrating the pump into the operator's protection concept.

## 2.13 Protection of environment

Environmental damage may be caused by the incorrect disposal of operating material and materials. For questions about environmental protection as well as national regulations, please consult your local disposal company.

- All operating materials as well as all gases, vapours or liquids, e.g. lubricating oil escaping during operation and maintenance must be collected and disposed of in an environmentally friendly manner.

### 3 Transport and storage

#### 3.1 Transport

**! WARNING**



**Death by falling down or tipping over of the transported goods!**

Falling or tipping over of transported goods can cause serious or fatal injuries. Limbs can be crushed.

- Select the lifting device according to the total weight to be transported.
- Secure the machine against tipping over and falling.
- Always attach the machine on all present load handling equipment.
- Do not stand underneath a suspended load.
- Put the goods to be conveyed on a horizontal base (max. inclination: 10° in all directions).

##### 3.1.1 Unpack and check the as-delivered condition

- Unpack the machine on receipt and check for transport damage.
- Immediately notify the manufacturer of transport damages.
- Check the scope of deliveries for completeness.
- Dispose of the packaging in accordance with the local regulations in force.

##### 3.1.2 Lift and transport

**! WARNING**



**Bodily injury resulting from improper operation!**

Improper operation of the lifting gear and the transported goods can cause serious or fatal injuries.

- Lift and transport the machine only on the permissible load handling equipment.
- Loads crosswise to the load handling equipment are not permitted.
- Avoid impact stress.
- Wear your personal protective equipment.

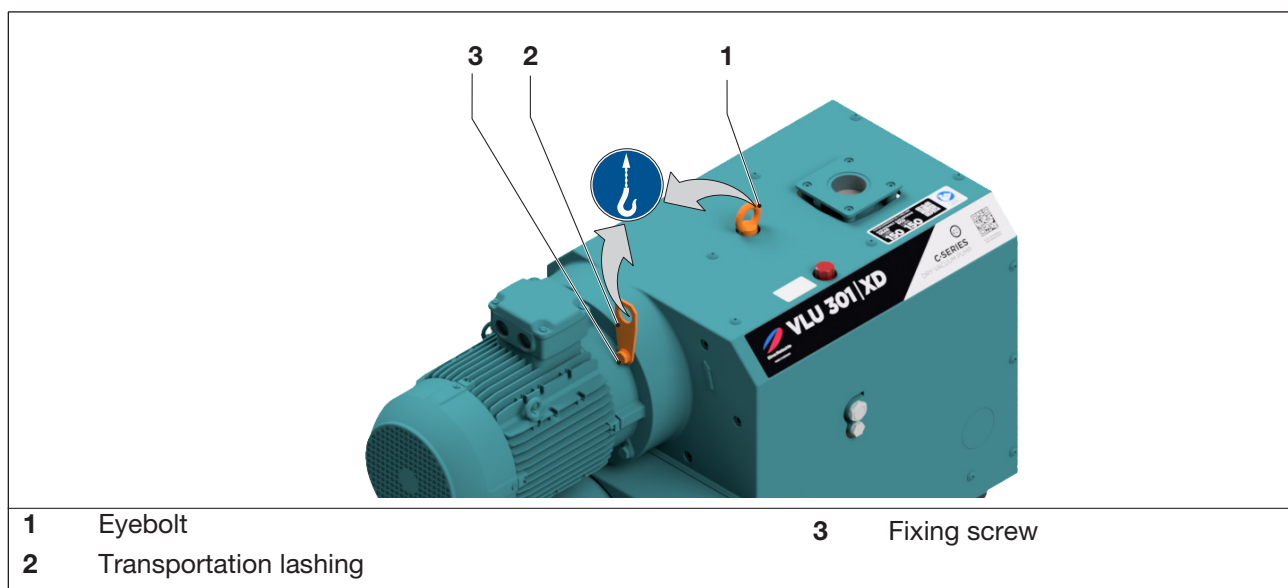

Fig. 1 Load handling equipment for lifting and transporting

The pump is supplied on a pallet.

- a) Unload the pump using a forklift or pallet truck and transport to the installation location.
- b) Tightly fasten the eyebolt (Fig. 1/1) and the fixing screw (Fig. 1/3) on the transportation lashing (Fig. 1/2).
- c) To lift and transport the machine, suspend it from the eyebolt using lifting gear.
- d) Lift the pump from the pallet and align.

### 3.2 Storage

#### NOTICE

#### Material damage caused by improper storage!

Improper storage can damage the machine.

- Observe the storage conditions described below.

#### 3.2.1 Ambient conditions during storage

- Dust-free
- In a dry place
- Vibration free
- Protected against sun radiation
- Storage temperature: -20 °C to +70 °C
- Rel. air humidity: max. 80 %
- Close the openings air-tight



The machine must be stored in a dry environment with normal air humidity. It should not be stored for more than 6 months.

📄 See Info "Storage instructions", page 4.

## 4 Product overview and functioning

### 4.1 Product Overview C-VLU 301

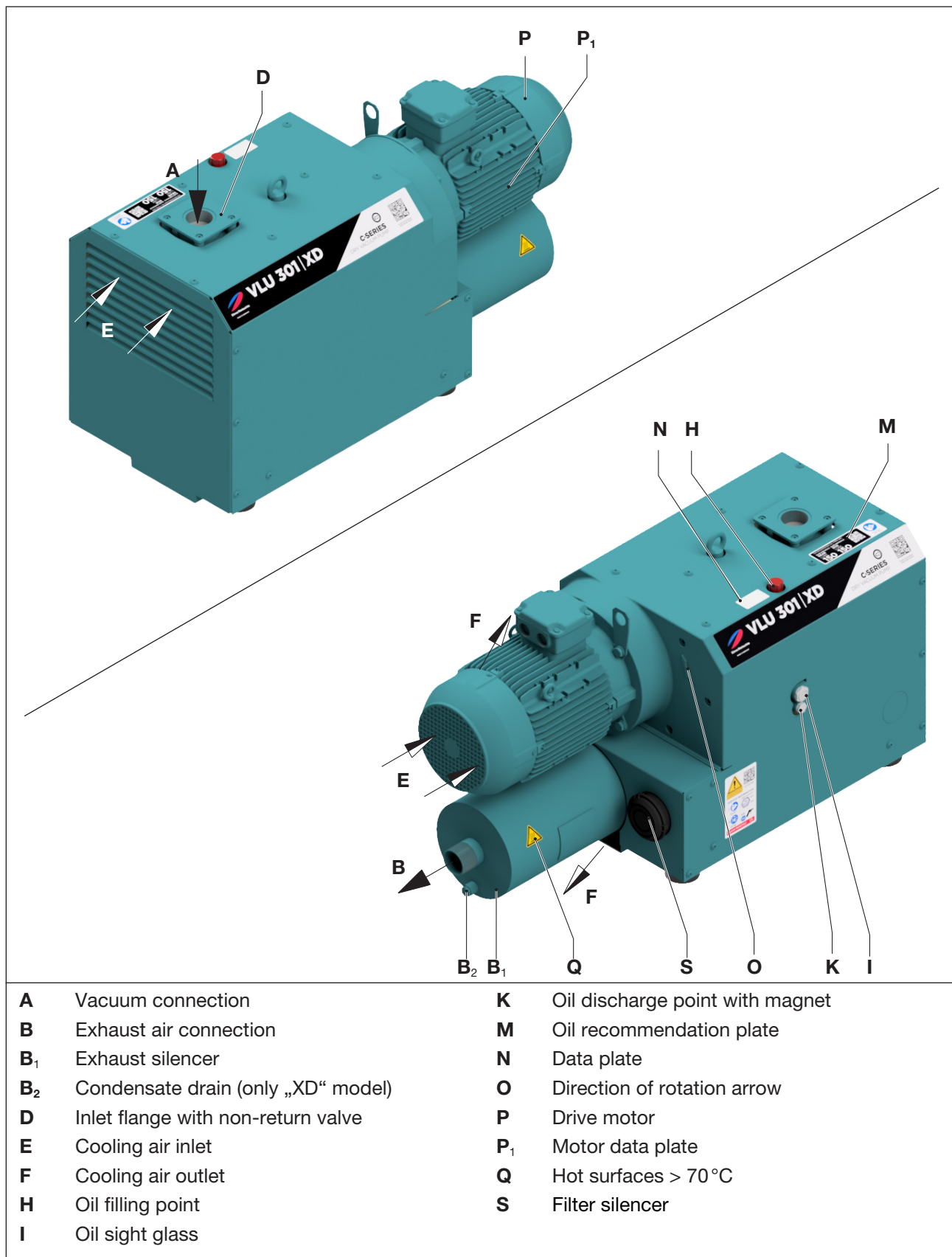

Fig. 2 Vacuum pump C-VLU 301 XD (CD version is identical).

## 4.2 Data plate

1	Model / size (mechanical version)	6	Speed 50 Hz / 60 Hz
2	Serial number	7	Motor output 50 Hz / 60 Hz
3	Year of construction	8	Operating mode
4	Data matrix barcode	9	Pumping capacity 50 Hz / 60 Hz
5	Article No.	10	Final pressure (abs.) 50 Hz / 60 Hz

Fig. 3 Data plate (example)

The following information is encoded as barcode:

- Material number (MA)
- Production order (PR)
- Serial Number (SC)

## 4.3 Description

The models C-VLU 301 are designed as double-shaft rotary piston vacuum pumps in which the claws roll against each other contact-free and dry. The counter-rotating claw rotors are synchronised by a gear pair in the gearbox. The gears of the synchronized gearbox and the bearings are lubricated with oil. These components are in a gearbox that also contains the oil supply. Oil conveying devices always ensure that the bearings and the gears are sufficiently supplied with oil at all permissible speeds. The gearbox and the compression chamber are separated from each other by special seals. The gearbox is sealed from the outside with piston sealing rings and O-rings, the compressor chamber with piston rings.

The C-VLU 301 have a connection flange on the inlet side and an exhaust silencer (Fig. 2/B,) on the pressure side. The intake air is cleaned by a mesh filter. An integral non-return valve prevents the evacuated system from being ventilated after the pump has stopped.

The C-VLU 301 are enclosed in an insulation hood. In order to dissipate compression heat, the cooling air is sucked through between the compressor and the hood using a drum fan that sucks in the fresh cooling air (Fig. 2/E) and discharges the heated air out of the cooling air outlet (Fig. 2/F). It is driven via a coupling by a flanged, three-phase standard motor.

## Product overview and functioning

### 4.4 Fields of application

These contact-free running claw vacuum pumps, C-VLU 301, can be operated in continuous operation at any pressure between **700 mbar (abs.)** and an inlet pressure of **30 mbar (abs.)**.

The pumping capacity with unrestricted suction is **265 m<sup>3</sup>/h** at **50 Hz**. Data sheet D 892 shows the dependency of the pumping capacity on the suction pressure.

Design XD: The vacuum pump is equipped with a corrosion-protective coating and is suitable for conveying water-damp gases (water vapour).



If the unit is switched on more frequently (at regular intervals of approx. 10 times per hour) or at higher ambient temperatures and inlet temperatures, excess temperature limit of the motor winding and the bearings may be exceeded.

Contact the manufacturer regarding such operating conditions.



If it is installed in the open air the unit must be protected from environmental influences (e.g. by a protective roof).



The minimum permissible end pressure of the machine is specified on the rating plate.

### 4.5 Accessories

The following accessories are options and on request available from Gardner Denver.

#### 4.5.1 Intake filter

The intake filter serves for the protection of the machine from dust and other solids in the process gas. The intake filter is available with a paper filter or a polyester filter.



## 5 Installation

We urgently recommend having the installation carried out by qualified specialist personnel. Gardner Denver does not accept liability for damages caused by improper carrying out of installation.

### 5.1 Preparation of installation

Ensure the following conditions:

- Machine freely accessible from all sides
- Do not close ventilation grids and holes
- Sufficient space for installing and removing pipes and for maintenance work, particularly for the installation and deinstallation of the machine
- No influence by external vibrations
- Hot exhaust air from other machines may not be sucked in the cooling system
- Oil filling point (Fig. 2/H), oil sight glasses (Fig. 2/I) and oil drain (Fig. 2/K) must easily be accessible.
- For maintenance works, provide for a space of **at least 50 cm** around the machine.

### 5.2 Installation

#### CAUTION

#### Burns due to hot exhaust gases!

Place the freely blowing machine in a way that hazards due to hot exhaust gases are prevented.

#### NOTICE

#### Property damage caused by improper installation!

Improper erection and installation can damage the machine.

- The machine may only be operated when it is set up horizontally (Max. inclination: 8° in all directions).
- Secure the machine against tipping over and falling.
- The floor must be plane and even.
- The bearing surface must be designed to be able to carry the weight of the machine (see chapter 10 “Technical Data”).
- If a non-return valve is integrated in the pump, it may not be removed.

#### NOTICE

#### Property damage from overheating!

Due to too low cooling capacity, the machine can overheat and can be damaged.

- Ensure for a good aeration and venting of the installation room. Observe the ambient temperature: min. +5 °C, max. +40 °C
- The cooling air inlets and the cooling air outlets must be **at least 30 cm** away from the adjacent walls. Cooling air coming out must not be sucked in again.

#### NOTICE

#### Property damage due to polluted inlet air!

Pollutions in the inlet air can damage the machine.

- To protect the machine the operator should install appropriate filters on the suction side.

- Align the pump at the installation location and if necessary, bolt to the substrate.
- If available, check optional accessories for the correct mounting and correct electrical connection.

## Installation



An output reduction is noticeable when installed at more than 1000m above sea level. In this case, please contact us.



It is possible to install the machine on a firm base without anchoring. When installing on a sub-structure we recommend fixing it with flexible buffers.

### 5.3 Connection of pipes



#### CAUTION

#### Risk of injury due to closed exhaust air opening!

Closed, restricted or covered exhaust air openings can cause too high back pressure in the machine.

- The exhaust air opening must not be closed or restricted.
- Do not install any blocking devices.
- Maximum permissible back pressure: +30 mbar  
If the back pressures are higher due to the process, please contact us.
- Prevent liquids from accumulating in the exhaust line.
- Before connecting hose or pipelines, the blind plugs at the exhaust air outlet must be removed.
- Regularly check the connected exhaust lines for pollution.
- Use only suitable pipelines.

#### NOTICE

#### Material damage resulting from too high forces and torques of the pipes acting on the unit!

If forces and torques during installation and operation are too high, the machine can be damaged.

- Only screw in pipes by hand.
- If necessary, use flexible connections.

The vacuum connection is located on the suction flange.

- Remove the blind plug/adhesive film on the vacuum connection (Fig. 2/A) and exhaust air outlet (Fig. 2/B).
- Connect the pipes with the vacuum connection (Fig. 2/A).
- The exhausted air can be blown out through the exhaust air outlet (Fig. 2/B) on the exhaust silencer (Fig. 2/B<sub>1</sub>) or led away using a hose or pipeline.  
To avoid distorting in the piping system, we recommend using compensators.
- Check that the maximum back pressure is not exceeded!



The suction capacity of the vacuum pump is reduced if the inlet pipe is too narrow and/or too long.

### 5.4 Check lubricating oil

- Check the lubricating oil level at the oil sight glass (Fig. 2/I).and top up if necessary.  
See chapter 7.5 on page 26.

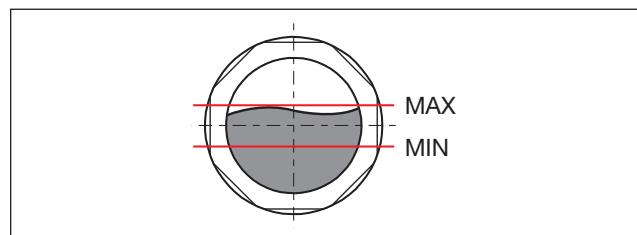

Fig. 4 Oil level in the sight glass

## 5.5 Connect to the energy supply network

### DANGER



#### **Danger to life if the electrical installation has not been carried out professionally!**

Installation that has not been carried out professionally or properly can cause serious injuries or death. The whole electrical system can be destructed.

- The electrical installation must only be carried out by a qualified electrician observing EN 60204.
- The main switch has to be provided by the user.
- The motor must be safeguarded via a motor protection switch. This must be installed by the operating company.

### NOTICE

#### **Property damage due to wrong energy supply!**

Wrong operating voltages, frequencies or currents can cause loss of power or damages to the machine.

- The conditions at the installation location must comply with the details on the motor data plate.

### 5.5.1 Connection of motor

Please find the electrical motor data on the data plate (Fig. 2/N) or the motor data plate (Fig. 2/P<sub>1</sub>). The motors comply with DIN EN 60034 and are designed in protection class IP 55 and insulation class F. The appropriate connection diagram is located in the terminal box of the motor (not existing for the version with plug connection).

Machines with AC-motors with apparent output higher than 1.7 kVA or three-phase motors with more than 5.2 kVA, or motors with start currents higher than 60 A are not designed for a direct start on the network.

High starting torques occur during the start of the motor. Therefore the mechanical load must be reduced.

For this purpose, for instance, the motor can be started by start-delta starting control, smooth starter, or frequency converter.

Permissible tolerances:

- ± 5 % Voltage deviation referred to nominal value
  - ± 2 % Frequency deviation
- a) Compare the motor data with the data of the existing mains network (current type, voltage, network frequency, permitted current value).
  - b) The direction of rotation of the motor must correspond with the direction of rotation arrow (Fig. 2/O) on the motor flange. Check the rotation direction!
  - c) Directly connect the motor in the terminal box or use the optional connector (accessories).  
For securing, a motor protection switch and a strain relief provide for a screwed cable connection to connect of the connecting cable.



We recommend using motor protection circuit breakers with delayed switch off, depending on a possible excess current. Temporary excess current can occur when the machine is started under cold conditions.

### 5.6 Connect pressure monitoring

#### NOTICE

#### Material damage

If the vacuum falls below the permissible level (see data plate: final pressure), the motor and pump may overheat. This can result in damage to the machine.

- Operation without pressure monitoring is not permitted.
- If the machine is supplied without pressure monitoring, the machine must be secured by the operator.

No pressure monitoring is fitted at the factory and therefore a pressure monitor must be installed by the customer to ensure that the pressure does not fall below the minimum permissible final pressure. If the pressure falls below the permissible final pressure, the pump must be switched off or brought into a safe operating state to prevent consequential damage.

The minimum permissible final pressure of the machine is noted on the rating plate.

Permissible tolerance:

- $\pm 5\%$  pressure deviation in relation to the nameplate data

## 6 Commissioning and decommissioning

### 6.1 Start-up

#### WARNING

##### **Risk of injury due to improper operation!**

Improper operation of the machine can cause serious or fatal injuries.

- Strictly observe the safety instructions. Especially observe the safety instructions in chapter 2 .

#### CAUTION

##### **Risk of burns on hot surfaces!**

When the machine is at operating temperature the surface temperatures on the components may rise to above 70 °C. This can cause serious burns.



- Do not touch hot surfaces (indicated by warning signs).
- Wear suitable protective gloves, if necessary.

#### CAUTION

##### **Risk of injury due to drawing in and trapping!**

Due to the high suction capacity possibly parts of the body are drawn in the inlet connection and injured.

- Do not put your hands onto the inlet connection to check the suction.
- By barriers or keeping sufficient distance make sure that parts of the body can be drawn into the inlet connection.

#### CAUTION

##### **Risk of injury due to noise emission!**

High sound pressure level can permanently damage hearing.



- Observe measured sound pressure level, see chapter 10.
- When spending a long time in the vicinity of the running machine use ear protection to avoid permanent damage to hearing.

#### NOTICE

##### **Property damage!**

Restarting of the machine if the machine has not stopped completely, can damage the machine.

- The machine is only allowed to be switched on again after it stands still.

#### NOTICE

##### **Property damage due to insufficient cooling!**

If the cooling air flow is reduced or interrupted, cooling of the machine cannot be ensured. This can cause reduced performance or blackout failure of the machine and damage the machine

lead to machine failure and damage the machine.

- Operation is only allowed with sufficient cooling air quantity
- Make sure that the cooling air flow is not interrupted

#### 6.1.1 Installation check

#### WARNING

##### **Risk of injury!**

A faulty installation as well as missing or non-functional safety equipment may lead to severe injury.

- Put the vacuum pump into operation only after it has been ensured that the installation is carried out flawless and the requirements for installation, assembly and electrical installation have been observed.

## Commissioning and decommissioning

The following checks must be carried out:

- no transport or assembly damage of the vacuum pump and assembly steps attached
- the vacuum pump is standing safely on the substrate at a horizontal installation position
- Correct connection of the pipelines (inlet side, outlet side), check for leak tightness!
- Tight fit of the screw and flange connections
- Electrical installation complies with the specifications (connection diagram)
- The installation room is equipped with an adequate ventilation system
- Oil filled and oil level checked
- vacuum pump and pipelines cleaned
- check the function of optional accessories (if present)

### 6.1.2 Check the rotation direction



**CAUTION**

#### Risk of injury due to wrong direction of rotation!

Rotating backwards for a longer time can cause injuries due to drawing in and can damage the machine.

- Use a phase sequence indicator to check the direction of rotation (**clockwise**).
- Keep a distance of 1 m to outlet and inlet connections.

The drive shaft direction of rotation is shown by the arrow for the direction of rotation (Fig. 2/O) on the motor flange.

- a) Start the motor briefly (max. two seconds) to check the direction of rotation. When looking at the motor blower, it must rotate counter-clockwise.

## 6.2 Operation

### 6.2.1 Discharge condensate



**CAUTION**



#### Risk of injury due to hot condensate!

If condensate is discharged manually, this can cause burns.

- Do not discharge the condensate manually.
- If there are any condensate drains on the machine, allow the machine to cool down before drain off the condensate.  
XD model:  
Depending on application, regularly discharge the condensate from the silencer through the condensate drain.
- Wear protective gloves.

**NOTICE**

#### Property damage due to formation of condensate and impurities!

Due to increased condensate formation and impurities, deposits may adhere to the rotors and the compressor casing after switching off the machine, preventing the start-up when restarting it. Condensate and impurities can cause damage to the machine.

- Before the decommissioning of the machine, drain off the condensate.

Before putting the pump out of operation for more than 2 hours or before decommissioning of the vacuum pump, remove moisture and pollution from the pump by running the vacuum pump at **500 mbar (abs.)** for at least **15 - 30 minutes** with dry air.



Depending on the use case, we recommend letting the vacuum pump run after with purging gas. Contact the manufacturer regarding such operating conditions.

## 6.3 Decommissioning

### 6.3.1 Decommissioning of the machine

#### DANGER



#### **Danger of death from touching live parts!**

Touching of live parts cause serious injuries or death.

- Disconnect the machine from the power supply by actuation of the main switch or disconnection of the plug and secure it against unexpected restart.
- Works on the electrical installation must be carried out by an electrician only.

#### CAUTION



#### **Risk of injury due to hot surfaces!**

When the machine is at operating temperature the surface temperatures on the components may rise to above 70 °C. This can cause burns.

- Avoid touching the hot surfaces. They are marked by warning signs.
- Wear suitable protective gloves, if necessary.

- a) Run the pump with dry air. See chapter 6.2.1
- b) Switch the machine off and allow it to cool down.
- c) If available, close the cut-off device in the suction and pressure line.
- d) Disconnect the machine from the power supply.
- e) Depressurise the machine:  
Open the pipes slowly.  
⇒ The pressure reduces slowly.
- f) Remove the pipes and hoses.
- g) Drain the condensate from the silencer (XD model)
- h) Seal the connections for inlet and outlet stubs using adhesive foil.

### 6.3.2 Storing the machine

 See also chapter 3.2, page 13

## 6.4 Recommissioning

- a) Check the condition of the machine (cleanliness, cabling etc.).

 For installation see chapter 5, page 17

 For commissioning, see chapter 6.1, page 21

## 7 Maintenance and repair

### DANGER



#### **Danger of death from touching live parts!**

Touching of live parts cause serious injuries or death.

- Before starting any maintenance work, disconnect the machine by actuation of the main switch or disconnection of the plug and secure it against accidental switching.
- Works on the electrical installation must be carried out by an electrician only.
- Repair works are only allowed to be done by authorised specialists.

### CAUTION



#### **Risk of injury due to hot surfaces!**

When the machine is at operating temperature the surface temperatures on the components may rise to above 70 °C. This can cause burns.

- Wait for the machine to cool down.
- Before maintenance and repair works allow the machine to cool down.
- Wear suitable protective clothes, if necessary.

### CAUTION

#### **Risk of injury due to missing safety devices!**

Missing safety devices can cause injuries.

- Safety devices as well as safety guards on motor fans and ventilators may not be removed.

### 7.1 Ensure operational safety

Regular maintenance work must be carried out in order to ensure operational safety.

The cleaning and oil change intervals strongly depend on how the machine is loaded (operating time, operating conditions, etc.) and the type of oil used. Depending on the pollution of the sucked in medium and the environmental conditions, the cleaning intervals of the air filter will be shorter. Extreme temperatures or pollutions can reduce the lifetime of the oil to 5,000 operating hours. The specified interval of up to 20,000 operating hours only applies to types of oil delivered or approved by Elmo Rietschle. Please find an overview in Tab. 4 on page 31.

For all works, observe the safety instructions described in chapter 2 “Safety”.

The whole plant should always be kept in a clean condition.



## 7.2 Maintenance table

Interval (Operating hours)	Maintenance activities	Chapter
At least 1 x per month	Check the pipes and screws for leaks and ensure their tight fit and if necessary re-seal or re-tighten.	—
	Check the terminal box and cable inlet holes for leaks and if necessary re-seal.	—
	Clean the ventilation slots on the machine and the motor cooling ribs.	—
	Check the oil level	Chapter 7.5.1
	Check, clean, and replace the air filters, if necessary	Chapter 7.6
Depending on the degree of pollution	Clean vacuum pump	Chapter 7.4
Depending on condensation	Drain the condensate from the silencer (XD model)	Chapter 6.2.1
20000 h	Oil change The oil change interval strongly depends on how the machine is loaded (operating time, operating conditions, etc.) and the type of oil used. Extreme load can reduce the lifetime of oil. The specified interval of 20,000 h only applies to oil that has been delivered or is approved by Elmo Rietschle.	Chapter 7.5.2
At least 1 x per year	Check couplings for wear	Chapter 7.7.2
As per manufacturer's instructions	Motor (maintenance, lubrication and cleaning)	Chapter 7.7.1
40000 h	General overhaul of the vacuum pump (replacement of wearing and sealing parts) (Elmo Rietschle Service)	—

Tab. 1 Maintenance table

## 7.3 Preparing maintenance works

- a) Switch the plant off electrically and secure it against unexpected restart.
- b) Vent the vacuum pump with atmospheric air; for this purpose open the shut-off valve.  
Exception: Clean the outside of the vacuum pump
- c) Allow the vacuum pump to fully cool down.  
Exception: Oil change, here the pump shall be still warm, because oil can then flow off better.
- d) Post the warning sign "Caution, maintenance works!".

## 7.4 Clean vacuum pump

The vacuum pump must regularly be checked for dust deposits and cleaned, if necessary. The cleaning interval depends on the operational requirements.

- a) Clean the vacuum pump with a damp cloth or using a vacuum cleaner. Remove dust deposits:
  - Pump housing
  - Between the cooling ribs of the motor
  - On the silencer and the piping
  - On the accessories attached

### 7.5 Lubricating Oil

#### CAUTION



#### **Risk of burns on hot equipment!**

There is the risk of burning on hot equipment when changing oil.

- Allow the machine to cool down to approx. 40 °C (lukewarm).
- Avoid contact with the hot oil because the oil temperature can be higher than the ambient external temperature of machine.
- Wear suitable protective gloves, if necessary.

#### CAUTION



#### **Risk of injury due to slipping and falling!**

The floor can be slippery due to leaked oil and cause slipping, tripping or falling.

- For oil change wear non-slip shoes.
- Remove leaked oil immediately.



Always change the oil when the machine is at operating temperature and in an atmospherically ventilated area. If it is not completely emptied, the refilling quantity is reduced.

If you change the type of oil, empty the oil tank completely.

A minimum oil quantity may escape from the vent screw due to pressure compensation. If larger quantities of oil escape, wash the internal filter of the vent screw.



The waste oil must be disposed of in compliance with the local environmental protection regulations.

As operating agent, we recommend Elmo Rietschle oils, see the recommendation for on plate (Fig. 5/M) as well as Tab. 3 on page 31:

- GEAR-LUBE 150
- ECO-GEAR-LUBE 150

The viscosity of the oil used must comply with ISO VG 150 as per DIN 3448. Also consider the safety data sheet of the oil type used.

If you want to change the oil type, please contact us.

#### **7.5.1 Check/refill oil level**

Check the oil level in the sight glasses (Fig. 5/I) every month.

- a) Switch the machine off, secure it against accidental switching on and vent to atmospheric pressure.
- b) Open the cap of the oil filling point (Fig. 5/H) and refill oil until it reaches the upper edge of the sight glass (Fig. 5/I).
- c) Close the oil filling point.

## 7.5.2 Oil change

Change oil after every 20000 operating hours.

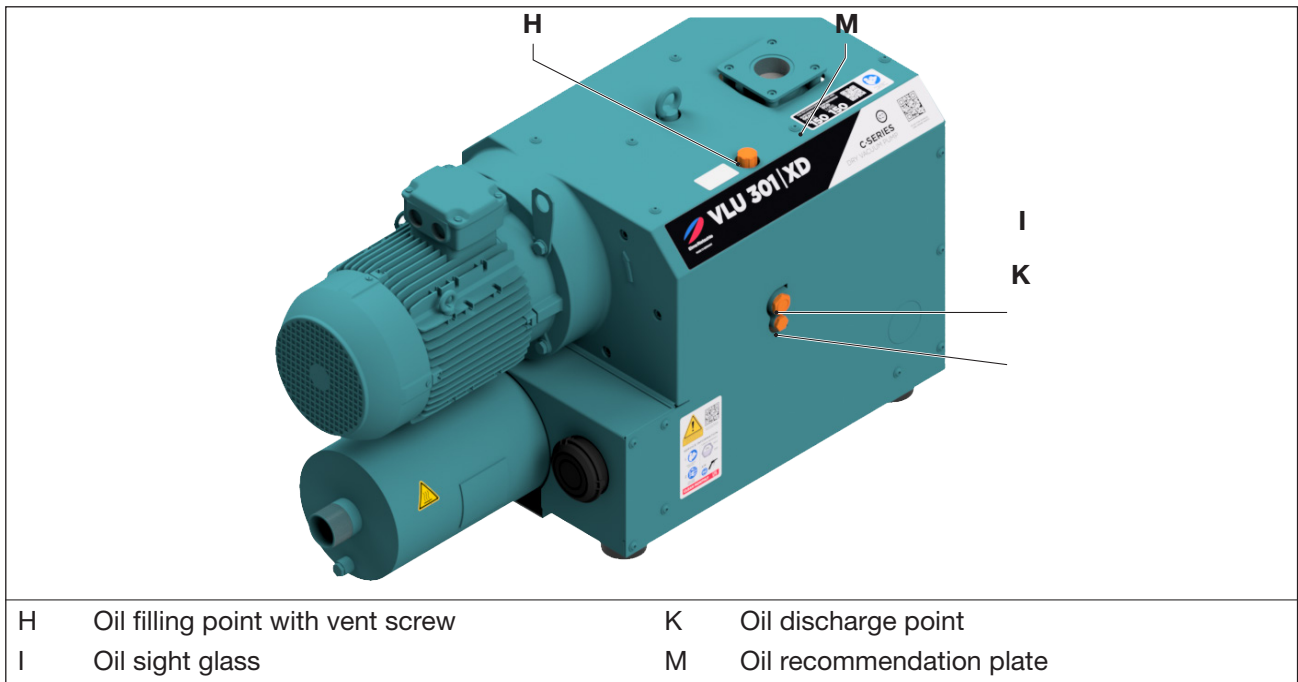

Fig. 5 Oil change

- Switch the machine off, secure it against accidental switching on and vent to atmospheric pressure. Let the machine cool down (lukewarm).
- Open the cap of the oil filling point (Fig. 5/H), open the oil discharge point (Fig. 5/K) and completely discharge the used oil.
- Close the oil discharge point (Fig. 5/K) and fill in new oil through the oil filling point (Fig. 5/H). Check the oil level in the sight glasses (Fig. 5/I).
- Close the screw in the oil filling point (Fig. 5/H).

## 7.6 Air filter

### CAUTION



#### Danger of injury when dealing with compressed air!

When the filter is blown off with compressed air, loose solid particles or powder dust swirling around may cause injury to the eyes. Inhaling can damage lungs.

- Wear protective glasses and dust mask when cleaning the filter with compressed air.

### NOTICE

#### Property damage due to insufficient maintenance of the air filter!

Performance of the machine is reduced by a polluted air filter and insufficient maintenance. This can cause damage of the machine.

- Regularly check and clean the integrated air filters.
- Replace highly polluted or damaged air filters.

## Maintenance and repair

### 7.6.1 Mesh filter

Clean or replace the mesh filter by washing or blowing off every month, or more often depending on the pollution of the sucked in medium.

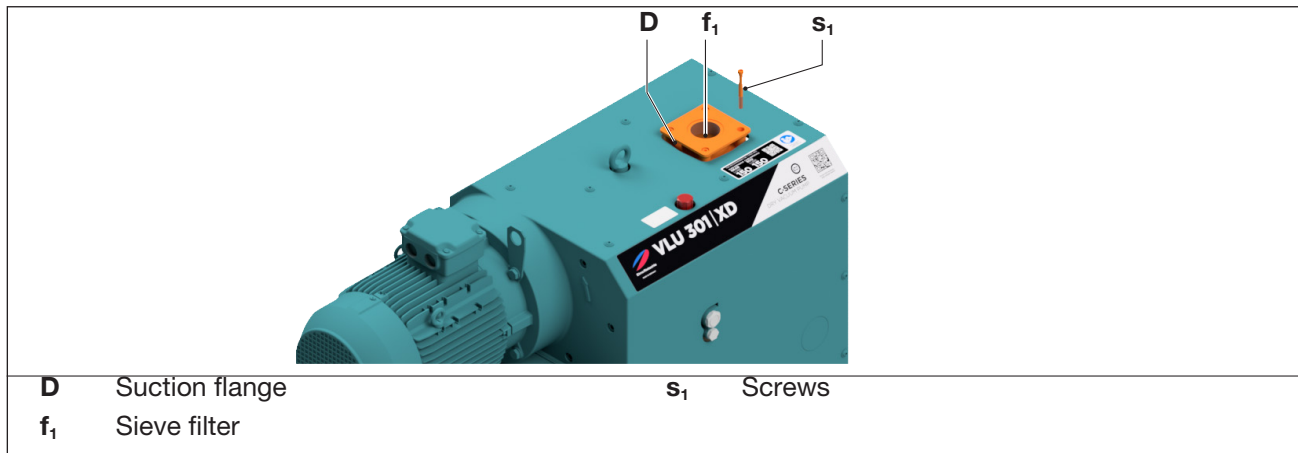

Fig. 6 Mesh filter

- Switch the machine off, relieve it to atmospheric pressure and allow the pump to cool down.
- Take off the inlet flange (Fig. 6/D) after releasing the screws (Fig. 6/s<sub>1</sub>).
- Clean the mesh filter (Fig. 6/f<sub>1</sub>). Also check the non-return valve (Fig. 6/D<sub>1</sub>) for pollution and clean it if necessary.
- Remount the intermediate flange (Fig. 6/D<sub>2</sub>) with mesh filter (Fig. 6/f<sub>1</sub>) as well as the inlet flange (Fig. 6/D) and tighten the screws (Fig. 6/s<sub>1</sub>). Tightening torque: 10 Nm.

### 7.6.2 Filter silencer

Clean the filter cartridge of the filter silencer every month or more often, depending on pollution of the sucked in ambient air, by blowing off from the inside to the outside. In spite of cleaning the filter its separation efficiency will continue to deteriorate. Therefore, the filter should be replaced every six months

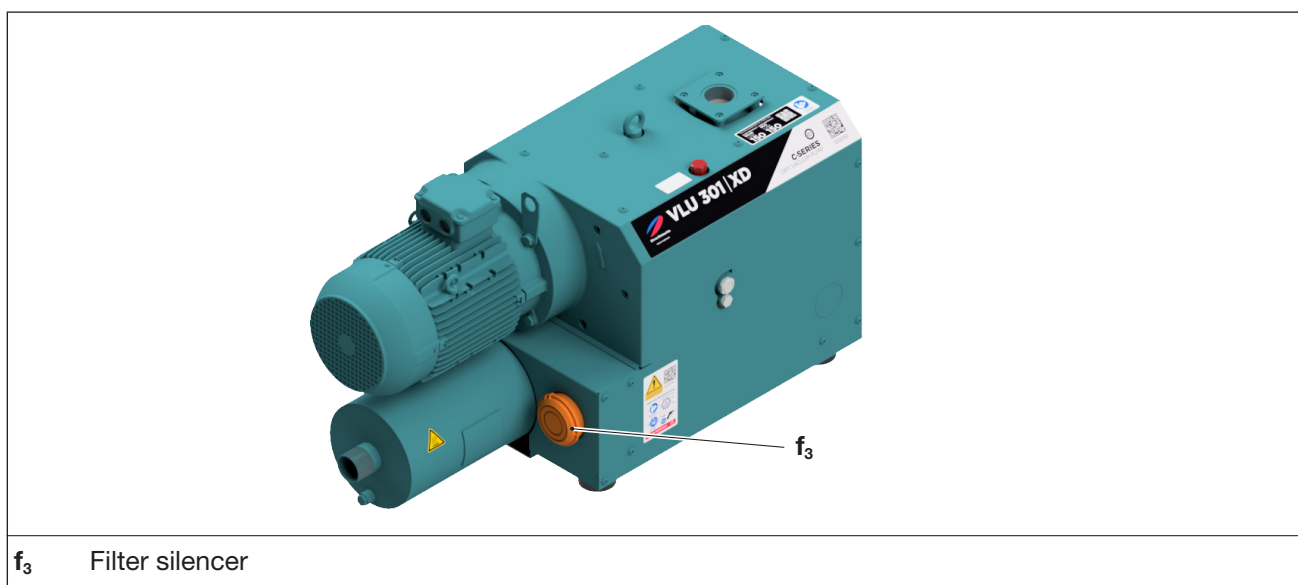

Fig. 7 Filter silencer

- Switch the machine off, relieve it to atmospheric pressure and allow the pump to cool down
- Take off the cover of the filter silencer (Fig. 7/f<sub>3</sub>).
- Remove the filter cartridge from the filter and clean it or replace it.
- Re-insert the filter cartridge and close the silencer with the cover.

### 7.6.3 Intake filter (accessories)

Clean the filter cartridge of the intake filter every month or more often, depending on pollution, by blowing off from the inside to the outside.

In spite of cleaning the filter its separation efficiency will continue to deteriorate. Therefore the filter should be replaced every six months.

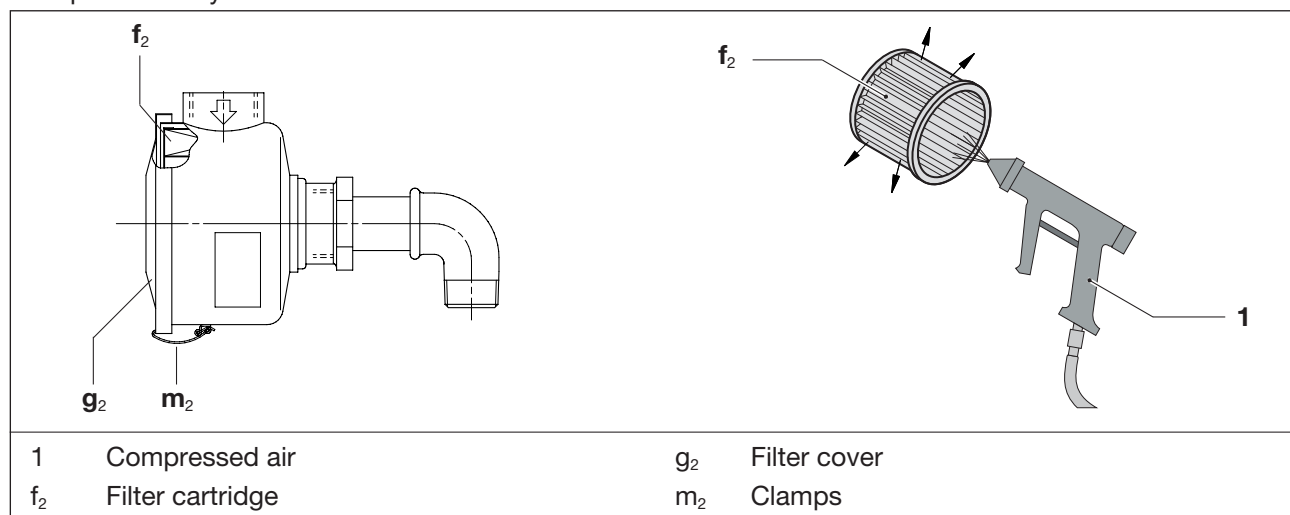

Fig. 8 Intake filter

- Switch the machine off, secure it against accidental switching on and vent to atmospheric pressure.
- Release the brackets (Fig. 8/m<sub>2</sub>) on the filter cover (Fig. 8/g<sub>2</sub>).
- Remove the filter cartridge (Fig. 8/f<sub>2</sub>) from the filter and clean or replace.
- Re-insert the filter cartridge in the filter and fasten the filter cover (Fig. 8/g<sub>2</sub>) with the brackets (Fig. 8/m<sub>2</sub>).

## 7.7 Motor and coupling

### 7.7.1 Motor



Perform the maintenance of the motor in accordance with the manufacturer's operating and maintenance instructions.

### 7.7.2 Coupling

#### NOTICE

#### Property damage due to defective coupling sprocket!

Defective sprockets can cause the rotor shaft to break and the machine to fail

- Regularly check the coupling tooth for wear.

#### NOTICE

#### Property damage due to frequent starting and high ambient temperature!

Frequent starting and high ambient temperature reduces the lifetime of the sprocket.

- Regularly check the coupling tooth for wear.

The clutch spider (Fig. 9/q) is subject to wear and must be checked regularly (at least once a year). The fan (Fig. 9/v) should also be checked for damage from time to time.

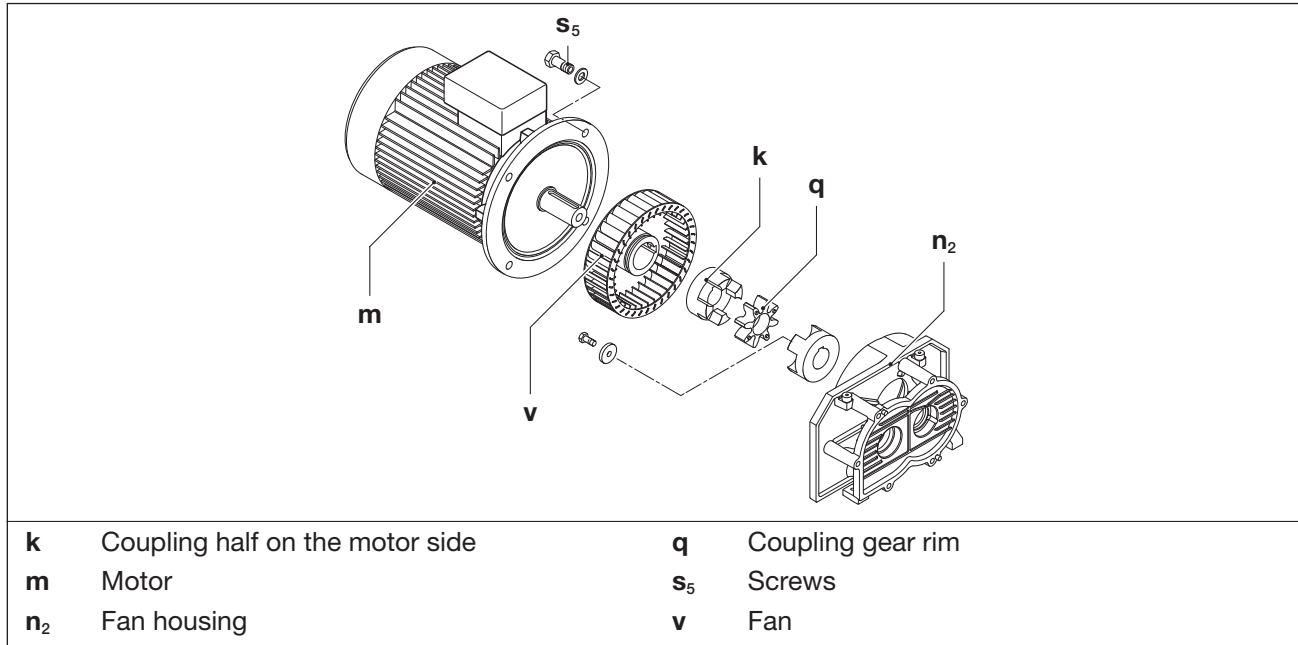

Fig. 9 Coupling

- Switch the machine off, secure it against accidental switching on and vent to atmospheric pressure. Allow the machine to cool down.
- Hook the motor (Fig. 9/m) in the eyebolts and lift it by means of lifting gear. If no eyebolts exist, suspend the Motor with round loops.
- Release the screws (Fig. 9/s<sub>5</sub>) on the motor flange and axially pull the motor with the half of the coupling on the motor side (Fig. 9/k) off the fan housing (Fig. 9/n<sub>2</sub>).
- Check the sprocket (Fig. 9/q). If the sprocket is damaged or worn, replace it.
- Check the fan (Fig. 9/v) and replace it, if necessary.
- Axially push on the gear rim and motor with coupling half on the motor side again and fix to the motor flange using the screws (Fig. 9/s<sub>5</sub>). Tightening torque: 84 Nm
- Remove the lifting gear from the motor.

## 7.8 Repair / service

For repairs contact the manufacturer, its branch offices or authorised dealers.

Please contact the manufacturer for the address of the authorized service centre (See address on the rear side).

### **WARNING**

#### **Risk of injury due to substances hazardous to health!**

Due to contamination with hazardous substances and operating agents during operation, there is a high health risk for the repair personnel.

- For each machine that is sent to an Elmo Rietschle Service centre for inspection, maintenance or repair, a fully completed, signed declaration of harmlessness must be enclosed.  
The Declaration of No Objection is part of the supplier's documentation.
- Before returning, properly clean the machine.

After a repair or before recommissioning, the measures listed in chapter 5 "Installation" and chapter 6 "Commissioning and decommissioning" must be carried out as for initial commissioning.

## 7.9 Spare parts

### NOTICE

#### Property damage due to wrong or defective spare parts!

Wrong or defective spare parts can cause malfunctions or blackout failure of the machine.

- Only use original spare parts or parts approved by the manufacturer.
- The use of other parts may revoke liability or guarantee for any resulting consequences.

Please find an overview of the spare parts in the **list of spare parts E892**.

Wearing parts and sealings are separately listed. For ordering spare parts, please contact the Elmo Rietschle Service (address on the back of the page).

For a simple and fast maintenance we are offering several service kits for our vacuum pumps. They include all wearing parts and sealings that are required for the respective maintenance works.

These service kits can directly be ordered from our Elmo Rietschle Service with quotation of the material numbers.

Ident no.	Description
ZS1183380	Coupling star
ZS1114498	Mesh filter
7320750000	Filter cartridge

Tab. 2 Spare parts

Oils can directly be ordered from our Elmo Rietschle Service with quotation of the material numbers.

Oil	Trading units	Material number	Description
<b>GEAR LUBE 150</b> 20.000 h	Dose, 1 l Fass, 200 l	7201706000 7201656000	Synthetic oil, highly loadable with high resistance to aging and with excellent wear protection Wear protection.
<b>ECO GEAR LUBE 150</b> 20.000 h	Dose, 1 l	7203850000	Synthetic oil, especially developed for the food and pharmaceutical industry. Refers to FDA 21 CFR 178.3570 and USDA H-1. With Halal and Koscher certificate.

Tab. 3 Oils

## 8 Errors



### Danger to life!

If malfunctions are disregarded and/or removed only insufficiently, serious to lethal injuries can occur.

- Never put the pump in operation again after it has been switched off automatically without unequivocally finding out the reason for this shut-off and remedying it.

Malfuction	Cause	Elimination	Note
Machine is switched off by the motor protection switch	Mains voltage/ Frequency does not correspond with the motor data	Check by qualified electrician	Chapter 5.5
	Connection to motor terminal board is not correct		
	Motor protection switch is not set correctly		
	Motor protection switch is triggered too quickly	Use a motor protection switch with an overload-dependent turn-off delay that considers the short excess current at start up (version with short circuit and overload trigger as per VDE 0660 Part 102 or IEC 60947-4-1)	
Suction capacity is insufficient	Air filter is polluted	Clean/replace air filter	Chapter 7.6 Chapter 7.9
	The inlet pipe is too long or too narrow	Check the hose and/or the pipe	Chapter 5.3
	Machine or system leaking	Check the pipework and screw connections for leaks and check for tight fit	Chapter 5.3
Final pressure (max. vacuum) is not reached	Machine or system leaking	Check the pipework and screw connections for leaks and check for tight fit	Chapter 5.3
	Air filter is polluted	Clean/replace air filter	Chapter 7.6 Chapter 7.9
Machine gets too hot	Ambient or inlet temperatures too high	Ensure proper use	Chapter 2.4
	Cooling air supply is obstructed	Check ambient conditions	Chapter 5.1
		Clean ventilation slots	Chapter 7.4
The machine makes a strange noise	Deposits on the rotary piston	Clean the working space and the rotary piston	Elmo Rietschle Service

Tab. 4 Table of malfunctions



Please contact Elmo Rietschle Service for other malfunctions or those that cannot be eliminated.



## 9 Disassembly and disposal

### 9.1 Disassembly



---

**Risk of injury due to substances hazardous to health!**

Due to contamination with hazardous substances and operating agents during operation, there is a high health risk for the personnel.

- Before disassembly, properly clean the machine.
- Wear suitable protective clothing.

- a) Put the machine out of service according to chapter 6.3.
- b) Disassemble the machine.  
Dismantle large components and assemblies.

### 9.2 Disposal

**NOTICE**

---

**Damage to the environment!**

Environmental damage may be caused by the incorrect disposal of operating material and materials.

- All operating materials, as well as all liquids, such as cooling water and cooling oil, required during operation and maintenance, must be collected and disposed of in an environmentally friendly manner.
- Separate components according to the materials and if possible, recycle.

- a) Collect oils and grease separately and dispose of in accordance with the local regulations in force.
- b) Do not mix solvents, cold cleaning agent and paint residues.
- c) Remove components and dispose of them in accordance with the local regulations in force.
- d) Dispose of the machine in accordance with the national and local regulations in force.
- e) Parts subject to wear and tear (marked as such in the spare parts list) are special waste and must be disposed of in accordance with the national and local waste laws.

## 10 Technical Data

C-VLU		301
Sound pressure level (max.) EN ISO 3744 Tolerance $\pm 3$ dB(A)	50 Hz	74,5
	60 Hz	78,5
Weight *	kg	283,5
Length *	mm	1093
Width	mm	495
Height	mm	600
Vacuum connection		G 2
Exhaust-air outlet		G 2
Condensate drain silencer		G 1/2
Oil filled volume	l	1,5

\* The length and weight may differ from the information given here depending on the motor make.

For further technical data, please refer to data sheet **D 892** → C-VLU 301



Subject to technical changes!



[www.elmorietschle.com](http://www.elmorietschle.com)  
er.de@irco.com

---

**Gardner Denver**  
**Schopfheim GmbH**  
Johann-Sutter-Straße 6+8  
79650 Schopfheim · Germany  
Phone +49 7622 392-0  
Fax +49 7622 392-300



Elmo Rietschle is a brand of Ingersoll Rand