

Gas-Ring Vacuum Pumps/Compressors

Operating Instructions

Series G_200

Types	2BH1 1	2BH1 3	2BH1 5	2BH1 8
	2BH1 2	2BH1 4	2BH1 6	2BH1 9



Single-impeller model
(single-stage)



Two-impeller model
(two-stage and double-flow)



Contents

1	Safety	3
1.1	Definitions	3
1.1.1	Safety alert symbol.....	3
1.1.2	Signal words.....	3
1.2	General safety precautions	3
1.3	Residual risks.....	5
2	Intended Use	6
3	Technical Data	7
3.1	Mechanical data	7
3.2	Electrical data.....	11
3.3	Operating conditions	11
4	Transport and Handling.....	11
5	Installation	12
5.1	Installation	13
5.2	Electrical connection (motor)	15
5.3	Connecting pipes/hoses (vacuum pump/compressor).....	17
5.3.1	Inlet connection	19
5.3.2	Discharge connection.....	19
5.3.3	Procedure when connecting pipes/hoses	19
6	Commissioning.....	19
6.1	Preparation.....	20
6.2	Start-up and shut-down.....	20
7	Operation.....	21
8	Shut-Down and Longer Standstills.....	21
8.1	Preparing for shut-down or longer standstill	21
8.2	Storage conditions	22
9	Servicing.....	22
9.1	Repairs/troubleshooting	22
9.2	Service/After-sales service.....	24
9.3	Decontamination and Declaration of Clearance	24
10	Disposal.....	24
11	Explosion-Protected Design.....	24
12	Declaration of Conformity.....	25

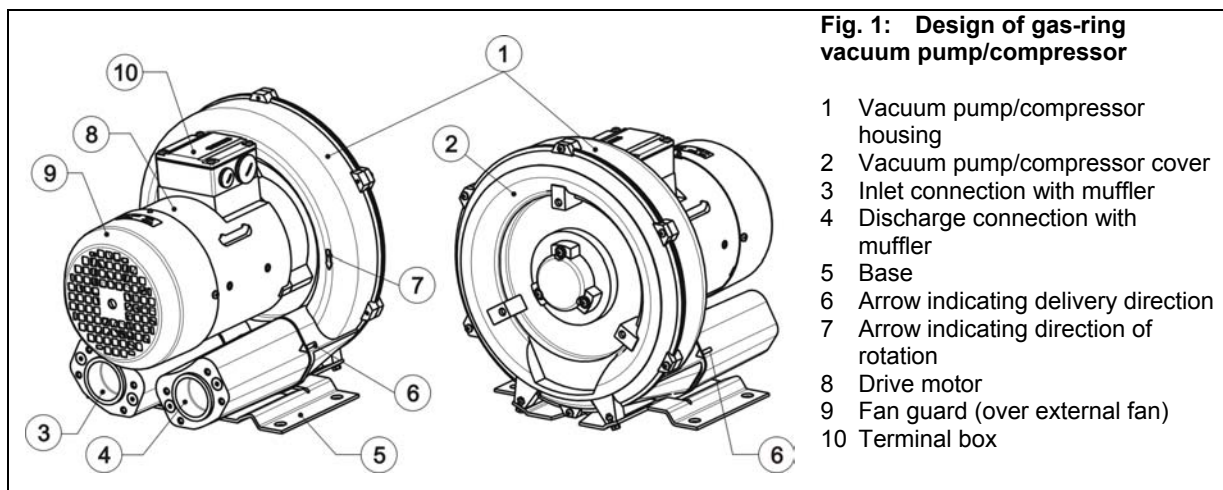

1 Safety

1.1 Definitions

To point out dangers and important information, the following signal words and symbols are used in these operating instructions:

1.1.1 Safety alert symbol

The **safety alert symbol**  is located in the safety precautions in the highlighted heading field on the left next to the signal word (DANGER, WARNING, CAUTION).

Safety precautions **with** a safety alert symbol indicate a danger of **injuries**.

Be sure to follow these safety precautions to protect against **injuries or death!**

Safety precautions **without** a safety alert symbol indicate a danger of **damage**.

1.1.2 Signal words

DANGER	The signal words are located in the safety precautions in the highlighted heading field.
WARNING	They follow a certain hierarchy and indicate (in conjunction with the safety alert symbol, see Chapter 1.1.1) the seriousness of the danger and the type of warning .
CAUTION	
NOTICE	
NOTE	See the following explanations:

 DANGER
Danger of injuries. Indicates an imminently hazardous situation, that will result in death or serious injury if the corresponding measures are not taken.

 WARNING
Danger of injuries. Indicates a potentially hazardous situation, that could result in death or serious injury if the corresponding measures are not taken.

 CAUTION
Danger of injuries. Indicates a potentially hazardous situation, that may result in minor or moderate injury if the corresponding measures are not taken.

CAUTION
Danger of damage. Indicates a potentially hazardous situation that may result in property damage if the corresponding measures are not taken.

NOTICE
Indicates a possible disadvantage , i.e. undesirable conditions or consequences can occur if the corresponding measures are not taken.

NOTE
Indicates a possible advantage if the corresponding measures are taken; tip.

1.2 General safety precautions

 WARNING
Improper use of the unit can result in serious or even fatal injuries! These operating instructions
<ul style="list-style-type: none"> • must have been read completely and understood before beginning any work with or at the pump-motor unit, • must be strictly observed, • must be available at the operating location of the pump-motor unit.

 WARNING
Improper use of the unit can result in serious or even fatal injuries! Only operate the pump-motor unit
<ul style="list-style-type: none"> • for the purposes indicated under "Intended Use"! • with the fluids indicated under "Intended Use"! • with the values indicated under "Technical Data"!

 WARNING
Improper use of the unit can result in serious or even fatal injuries! All work on and with the pump-motor unit (transport, installation, operation, shut-down, maintenance, disposal) may only be carried out by trained, reliable expert personnel!

 WARNING
When working on the unit, there is a danger of injury, e.g. in the form of cuts/cutting off, crushing and burns! During all work on and with the pump-motor unit (transport, installation, operation, shut-down, maintenance, disposal) wear personal safety equipment (safety helmet, protective gloves, safety shoes)!

⚠ WARNING

Hair and clothing can be pulled into the unit or caught and wound up moving parts!
Do not wear long, loose hair or wide, loose clothes! Use a hair net!

⚠ DANGER

Electrical danger!
Work on electrical installations may be carried out by trained and authorized electricians only!

⚠ DANGER

Electrical danger!
Before beginning work on the unit or system, the following measures must be carried out:

- Deenergize.
- Secure against being switched on again.
- Determine whether deenergized.
- Ground and short-circuit.
- Cover or block off adjacent energized parts.

⚠ DANGER

Electrical danger!
Do not open the motor terminal box until absence of electricity has been ensured!

⚠ WARNING

Danger due to vacuum and gauge pressure: sudden escape of fluids (skin and eye injuries), sudden drawing in of hair and clothing!
Danger due to escaping fluid: Burns!
Use mounting elements, connections, lines, fittings and containers with sufficient freedom from leaks and strength for the pressures which occur.
Check the mounting elements, connections, lines, fittings and containers for strength, leaks and firm seating at regular intervals!

⚠ WARNING

**Danger from rotating parts (external fan, impeller, shaft):
Cutting/cutting off of extremities,
Grasping/winding up of hair and clothing!**
Danger due to vacuum and gauge pressure: sudden escape of fluids (skin and eye injuries), sudden drawing in of hair and clothing!
Danger due to escaping fluid: Burns!
Start-up and operation only under the following conditions:

- The pump-motor unit must be completely assembled. When doing so, pay particular attention to the following components:
 - the vacuum pump/compressor cover,
 - the muffler on inlet and discharge connections,
 - the fan guard.
- The pipes/hoses must be connected to inlet and discharge connections.
- Inlet and discharge connections and the connected pipes/hoses may not be closed, clogged or soiled.
- Check the mounting elements, connections of the pipe/hose connections, lines, fittings and containers for strength, leaks and firm seating at regular intervals.

⚠ WARNING

**Danger from rotating parts (external fan, impeller, shaft):
Cutting/cutting off of extremities,
Grasping/winding up of hair and clothing!**
Danger due to vacuum and gauge pressure: sudden escape of fluids (skin and eye injuries), sudden drawing in of hair and clothing!
Danger due to escaping fluid: Burns!
Before beginning work on the pump-motor unit, take the following measures:

- Shut down pump-motor unit and secure against being switched on again.
- Attach a sign on the system controller and on the control elements for the pump-motor unit: "DANGER! Maintenance work on vacuum pump/compressor! Do not switch on!"
- Wait for pump-motor unit to come to a complete stop. Observe run-on time!
- Allow pump-motor unit to cool!
- Shut-off lines. Release pressure.
- Make sure that no vacuum or gauge pressure is present in the lines/tanks to be opened.
- Make sure that no fluids can escape.

⚠ WARNING**Danger from rotating impeller:
Cutting/cutting of off extremities!**

The rotating impeller is accessible with the inlet and discharge connections open!

Do not reach into the unit through open connections!

Do not insert objects into the unit through the openings!

⚠ WARNING**Danger from rotating impeller:
Cutting/cutting of off extremities!**

The rotating impeller is accessible with the inlet and discharge connections open!

With free entry and exit of gases, i.e. with direct intake out of or direct feeding into the atmosphere without piping, the following therefore applies:

Provide the inlet and discharge connections of the pump-motor unit either with additional mufflers or with additional piping of a sufficient length to prevent access to the impeller!

⚠ WARNING**Danger of burns from hot surfaces of the pump-motor unit and from hot fluids!**

High temperatures of up to approx. 160°C [320 °F] can occur on the surface of the pump-motor unit.

Cover the pump-motor unit with a suitable touch protection (e.g. perforated plate cover or wire cover). Do not touch during operation! Allow to cool after shut-down!

1.3 Residual risks**⚠ WARNING****Danger zone:**

Hot surface up to approx. 160°C [320 °F].

Hazard:

Possible burns.

Protective measures:

Cover the pump-motor unit with a suitable touch protection (e.g. perforated plate cover or wire cover).

⚠ WARNING**Danger zone:**

Fan guard

Hazard:

Long, loose hair can be drawn into external fan through fan guard grate, even with fan guard mounted!

Protective measures:

Wear hair net!

⚠ WARNING**Danger zone:**

Missing or defective muffler inlet or discharge connection.

Hazard:

Possible serious hearing damage due to emitted noise.

Protective measures:

Have missing or defective mufflers replaced. Conduct a noise measurement in the system after installing the pump-motor unit. The following measures can be taken from 85 dB(A) and must be taken from 90 dB(A):

- Mark noise area with a warning sign.
- Wear hearing protection.

⚠ WARNING**Danger zone:**

Environment of pump-motor unit.

Hazard:

Possible serious hearing damage due to emitted noise.

Protective measures:

Conduct a noise measurement in the system during operation after installing the pump-motor unit.

The following measures can be taken from 85 dB(A) and must be taken from 90 dB(A):

- Mark noise area with a warning sign.
- Wear hearing protection.
- With free entry and exit of gases, i.e. with direct intake out of or direct feeding into the atmosphere without piping, attach an additional muffler.

2 Intended Use

These operating instructions

- apply to gas-ring vacuum pumps/compressors of the G_200 series, types 2BH1 1, 2BH1 2, 2BH1 3, 2BH1 4, 2BH1 5, 2BH1 6, 2BH1 8 and 2BH1 9,
- contains instructions bearing on transport and handling, installation, commissioning, operation, shut-down, storage, servicing and disposal of the G_200,
- must be completely read and understood by all operating and servicing personnel before beginning to work with or on the G_200,
- must be strictly observed,
- must be available at the site of operation of the G_200.

About the operating and servicing personnel of the G_200:

- These persons must be trained and authorized for the work to be carried out.
- Work on electrical installations may be carried out by trained and authorized electricians only.

The G_200s

- are pump-motor units for generating vacuum or gauge pressure;
- are used to **extract, pump and compress the following gases:**
 - Air,
 - Non-flammable, non-aggressive, non-toxic and non-explosive gases or gas-air mixtures.
 - With differing gases/gas-air mixtures, inquire with the Service Department.
- are equipped with one of the following kind of drive motors:
 - 3-phase AC drive motor with a standard or explosion-protected design
 - Single-phase AC drive motor

These operating instructions apply **only** to pump-motor units with a **standard design**. For an explosion-protected design (EEx e II), see the separate operating instructions.

- exist in the following designs:
 - single-impeller
 - two-impeller

The two-impeller pump-motor units in turn differ in the following designs:

- two-stage design (for increased pressure difference)
- double-flow design (for increased feed volume)
- are intended for industrial applications,
- are designed for continuous operation. With an increased switch-on frequency or an increased gas entry and ambient temperature, the limit overtemperature of the winding and the bearing can be exceeded. Consultation with the Service Department is required for operating conditions of this kind.

When operating the G_200, the limits listed in Chapter 3, "Technical Data", Pg. 7 ff. must always be complied with.

Foreseeable Misuse

It is prohibited

- to use the G_200 in applications other than industrial applications unless the necessary protection is provided on the system, e.g. guards suitable for children's fingers;
- to use the device in rooms in which explosive gases can occur if the G_200 is not expressly intended for this purpose;
- to extract, to deliver and to compress explosive, flammable, corrosive or toxic fluids, unless the G_200 is specifically designed for this purpose;
- to operate the G_200 with values other than those specified in Chapter 3, "Technical Data", Pg. 7 ff.

Any unauthorized modifications of the G_200 are prohibited for safety reasons.

The operator is only permitted to perform the maintenance and service work described in these operating instructions.

Any maintenance and service work which goes beyond this may only be performed by companies authorized by the manufacturer (inquire with the Service Department).

3 Technical Data

3.1 Mechanical data

Weight

Single-impeller design		
Type	Weight	
	[kg]	[lbs]
2BH1100-7..0.	approx. 9	approx. 20
2BH1200-7..0.	approx. 9	approx. 20
2BH1300-7..0.	approx. 9	approx. 20
2BH1300-7..1.	approx. 10	approx. 22
2BH1300-7..2.	approx. 11	approx. 24
2BH1330-7..0.	approx. 10	approx. 22
2BH1330-7..1.	approx. 11	approx. 24
2BH1330-7..2.	approx. 12	approx. 26
2BH1400-7..0.	approx. 13	approx. 29
2BH1400-7..1.	approx. 16	approx. 35
2BH1400-7..2.	approx. 17	approx. 37
2BH1430-7..0.	approx. 14	approx. 31
2BH1430-7..1.	approx. 17	approx. 37
2BH1430-7..2.	approx. 18	approx. 40
2BH1500-7..0.	approx. 20	approx. 44
2BH1500-7..1.	approx. 22	approx. 49
2BH1500-7..2.	approx. 23	approx. 51
2BH1500-7..3.	approx. 25	approx. 55
2BH1500-7..6.	approx. 28	approx. 62
2BH1530-7..0.	approx. 21	approx. 46
2BH1530-7..1.	approx. 23	approx. 51
2BH1530-7..2.	approx. 24	approx. 53
2BH1530-7..3.	approx. 26	approx. 57
2BH1530-7..6.	approx. 29	approx. 64
2BH1600-7..0.	approx. 27	approx. 60
2BH1600-7..1.	approx. 30	approx. 66
2BH1600-7..2.	approx. 36	approx. 79
2BH1600-7..3.	approx. 40	approx. 88
2BH1600-7..6.	approx. 32	approx. 71
2BH1600-7..7.	approx. 39	approx. 86
2BH1630-7..0.	approx. 29	approx. 64
2BH1630-7..1.	approx. 32	approx. 71
2BH1630-7..2.	approx. 37	approx. 82
2BH1630-7..3.	approx. 43	approx. 95
2BH1630-7..6.	approx. 34	approx. 75
2BH1630-7..7.	approx. 40	approx. 88
2BH180.-7..0.	approx. 117	approx. 258
2BH180.-7..1.	approx. 126	approx. 278
2BH180.-7..2.	approx. 132	approx. 291
2BH183.-7..0.	approx. 120	approx. 265
2BH183.-7..1.	approx. 129	approx. 284
2BH183.-7..2.	approx. 135	approx. 298
2BH190.-7..0.	approx. 179	approx. 395
2BH190.-7..1.	approx. 198	approx. 437
2BH190.-7..3.	approx. 210	approx. 463
2BH193.-7..0.	approx. 179	approx. 395
2BH193.-7..1.	approx. 198	approx. 437
2BH193.-7..3.	approx. 209	approx. 463

Two-impeller design		
Type	Weight	
	[kg]	[lbs]
2BH1310-7..2.	approx. 15	approx. 33
2BH1410-7..3.	approx. 25	approx. 55
2BH1410-7..4.	approx. 27	approx. 60
2BH1510-7..4.	approx. 40	approx. 88
2BH1510-7..5.	approx. 44	approx. 97
2BH1610-7..1.	approx. 43	approx. 95
2BH1610-7..2.	approx. 48	approx. 106
2BH1610-7..3.	approx. 54	approx. 119
2BH1610-7..4.	approx. 66	approx. 146
2BH1610-7..5.	approx. 73	approx. 161
2BH1610-7..7.	approx. 50	approx. 110
2BH1610-7..8.	approx. 62	approx. 137
2BH1640-7..3.	approx. 54	approx. 119
2BH1640-7..4.	approx. 69	approx. 152
2BH1640-7..5.	approx. 75	approx. 165
2BH1640-7..8.	approx. 62	approx. 137
2BH181.-7..1.	approx. 171	approx. 377
2BH181.-7..2.	approx. 177	approx. 390
2BH181.-7..3.	approx. 203	approx. 448
2BH181.-7..4.	approx. 215	approx. 474
2BH184.-7..2.	approx. 177	approx. 390
2BH184.-7..3.	approx. 203	approx. 448
2BH191.-7..1.	approx. 281	approx. 619
2BH191.-7..2.	approx. 295	approx. 650
2BH191.-7..3.	approx. 306	approx. 675
2BH1940-7B.2.	approx. 275	approx. 606
2BH1940-7B.3.	approx. 314	approx. 692
2BH1940-7B.4.	approx. 324	approx. 714
2BH1943-7..2.	approx. 330	approx. 728
2BH1943-7..3.	approx. 339	approx. 747
2BH1943-7..4.	approx. 349	approx. 769

Minimum distances

Minimum distance to fan guard (for sucking in cooling air):

Type	Minimum distance to fan guard	
	[mm]	[inches]
2BH1 1..	34	1.34
2BH1 2..	34	1.34
2BH1 3..	34	1.34
2BH1 4..	34	1.34
2BH1 5..	53	2.09
2BH1 6..	53	2.09
2BH1 8..	53	2.09
2BH1 9..	53	2.09

Minimum distances to vacuum pump/compressor cover:

Type	Minimum distance to face of vacuum pump/compressor cover	
	[mm]	[inches]
2BH1 1..	20	0.79
2BH1 2..	20	0.79
2BH1 3..	20	0.79
2BH1 4..	20	0.79

Type	Minimum distance to face of vacuum pump/compressor cover	
	[mm]	[inches]
2BH1 5..	20	0.79
2BH1 6..	30	1.18
2BH1 8..	40	1.57
2BH1 9..	40	1.57

Noise level

Measuring-surface sound-pressure level as per DIN 45635, T13, measured at a distance of 1 m [3.28 ft] at an operating point of approximately 2/3 of the permissible total pressure difference with the lines connected without a vacuum or pressure relief valve.

Single-impeller design		
Type	1-m measuring-surface sound pressure level L [dB (A)]	
	at 50 Hz:	at 60 Hz:
2BH1100-7..0.	approx. 52	approx. 55
2BH1200-7..0.	approx. 57	approx. 61
2BH1300-7..0.	approx. 53	approx. 56
2BH1300-7..1.	approx. 53	approx. 56
2BH1300-7..2.	approx. 53	approx. 56
2BH1330-7..0.	approx. 53	approx. 56
2BH1330-7..1.	approx. 53	approx. 56
2BH1330-7..2.	approx. 53	approx. 56
2BH1400-7..0.	approx. 63	approx. 64
2BH1400-7..1.	approx. 63	approx. 64
2BH1400-7..2.	approx. 63	approx. 64
2BH1430-7..0.	approx. 63	approx. 64
2BH1430-7..1.	approx. 63	approx. 64
2BH1430-7..2.	approx. 63	approx. 64
2BH1500-7..0.	approx. 64	approx. 70
2BH1500-7..1.	approx. 64	approx. 70
2BH1500-7..2.	approx. 64	approx. 70
2BH1500-7..3.	approx. 64	approx. 70
2BH1500-7..6.	approx. 64	approx. 70
2BH1530-7..0.	approx. 64	approx. 70
2BH1530-7..1.	approx. 64	approx. 70
2BH1530-7..2.	approx. 64	approx. 70
2BH1530-7..3.	approx. 64	approx. 70
2BH1530-7..6.	approx. 64	approx. 70
2BH1600-7..0.	approx. 69	approx. 72
2BH1600-7..1.	approx. 69	approx. 72
2BH1600-7..2.	approx. 69	approx. 72
2BH1600-7..3.	approx. 69	approx. 72
2BH1600-7..6.	approx. 69	approx. 72
2BH1600-7..7.	approx. 69	approx. 72
2BH1630-7..0.	approx. 69	approx. 72
2BH1630-7..1.	approx. 69	approx. 72
2BH1630-7..2.	approx. 69	approx. 72
2BH1630-7..3.	approx. 69	approx. 72
2BH1630-7..6.	approx. 69	approx. 72
2BH1630-7..7.	approx. 69	approx. 72
2BH180.-7..0.	approx. 70	approx. 74
2BH180.-7..1.	approx. 70	approx. 74
2BH180.-7..2.	approx. 70	approx. 74

Single-impeller design		
Type	1-m measuring-surface sound pressure level L [dB (A)]	
	at 50 Hz:	at 60 Hz:
2BH183.-7....	approx. 76	approx. 79
2BH190.-7..0.	approx. 74	approx. 79
2BH190.-7..1.	approx. 74	approx. 79
2BH190.-7..3.	approx. 74	approx. 79
2BH193.-7....	approx. 71	approx. 75

Two-impeller design		
Type	1-m measuring-surface sound pressure level L [dB (A)]	
	at 50 Hz:	at 60 Hz:
2BH1310-7..2.	approx. 55	approx. 61
2BH1410-7..3.	approx. 66	approx. 69
2BH1410-7..4.	approx. 66	approx. 69
2BH1510-7..4.	approx. 72	approx. 74
2BH1510-7..5.	approx. 72	approx. 74
2BH1610-7..1.	approx. 73	approx. 76
2BH1610-7..2.	approx. 73	approx. 76
2BH1610-7..3.	approx. 73	approx. 76
2BH1610-7..4.	approx. 73	approx. 76
2BH1610-7..5.	approx. 73	approx. 76
2BH1610-7..7.	approx. 73	approx. 76
2BH1610-7..8.	approx. 73	approx. 76
2BH1640-7..3.	approx. 74	approx. 78
2BH1640-7..4.	approx. 74	approx. 78
2BH1640-7..5.	approx. 74	approx. 78
2BH1640-7..8.	approx. 74	---
2BH181.-7..1.	approx. 74	---
2BH181.-7..2.	approx. 74	approx. 78
2BH181.-7..3.	approx. 74	approx. 78
2BH181.-7..4.	approx. 74	approx. 78
2BH184.-7..2.	approx. 74	approx. 78
2BH184.-7..3.	approx. 74	approx. 78
2BH191.-7..1.	approx. 74	approx. 84
2BH191.-7..2.	approx. 74	approx. 84
2BH191.-7..3.	approx. 74	approx. 84
2BH1943-7..2.	approx. 75	approx. 84
2BH1943-7..3.	approx. 75	approx. 84
2BH1943-7..4.	approx. 75	approx. 84

Temperature increase

The information listed in the following tables corresponds to the heating of vacuum pump/compressor housings and the air exiting compared to the ambient temperature during operation with a permissible total pressure difference and an air pressure of 1,013 mbar [14.7 psi]. At lower air pressures these values increase.

Single-impeller design (at a frequency of 50 Hz)		
Type	Temperature increase	
	ΔT [K]	$\Delta \theta$ [F]
2BH1100-7..0.	ca. 46	ca. 115
2BH1200-7..0.	ca. 18	ca. 65
2BH1300-7..0.	ca. 32	ca. 90
2BH1300-7..1.	ca. 32	ca. 90
2BH1300-7..2.	ca. 32	ca. 90
2BH1330-7..0.	ca. 27	ca. 81
2BH1330-7..1.	ca. 44	ca. 111
2BH1330-7..2.	ca. 44	ca. 111
2BH1400-7..0.	ca. 37	ca. 99
2BH1400-7..1.	ca. 54	ca. 129
2BH1400-7..2.	ca. 65	ca. 149
2BH1430-7..0.	ca. 30	ca. 86
2BH1430-7..1.	ca. 57	ca. 135
2BH1430-7..2.	ca. 80	ca. 176
2BH1500-7..0.	ca. 30	ca. 86
2BH1500-7..1.	ca. 46	ca. 115
2BH1500-7..2.	ca. 59	ca. 138
2BH1500-7..3.	ca. 95	ca. 203
2BH1500-7..6.	ca. 120	ca. 248
2BH1530-7..0.	ca. 25	ca. 77
2BH1530-7..1.	ca. 46	ca. 115
2BH1530-7..2.	ca. 66	ca. 151
2BH1530-7..3.	ca. 95	ca. 203
2BH1530-7..6.	ca. 95	ca. 203
2BH1600-7..0.	ca. 27	ca. 81
2BH1600-7..1.	ca. 63	ca. 145
2BH1600-7..2.	ca. 77	ca. 171
2BH1600-7..3.	ca. 107	ca. 225
2BH1600-7..6.	ca. 120	ca. 248
2BH1600-7..7.	ca. 120	ca. 248
2BH1630-7..0.	ca. 35	ca. 95
2BH1630-7..1.	ca. 65	ca. 149
2BH1630-7..2.	ca. 120	ca. 248
2BH1630-7..3.	ca. 120	ca. 248
2BH1630-7..6.	ca. 120	ca. 248
2BH1630-7..7.	ca. 120	ca. 248
2BH180.-7..0.	ca. 40	ca. 104
2BH180.-7..1.	ca. 67	ca. 153
2BH180.-7..2.	ca. 120	ca. 248
2BH183.-7....	ca. 60	ca. 140
2BH190.-7..0.	ca. 36	ca. 97
2BH190.-7..1.	ca. 83	ca. 182
2BH190.-7..3.	ca. 110	ca. 230
2BH193.-7....	ca. 116	ca. 241

Single-impeller design (at a frequency of 60 Hz)		
Type	Temperature increase	
	ΔT [K]	$\Delta \theta$ [F]
2BH1100-7..0.	ca. 58	ca. 136
2BH1200-7..0.	ca. 38	ca. 101
2BH1300-7..0.	ca. 25	ca. 77
2BH1300-7..1.	ca. 60	ca. 140
2BH1300-7..2.	ca. 70	ca. 158
2BH1330-7..0.	ca. 25	ca. 77
2BH1330-7..1.	ca. 56	ca. 133
2BH1330-7..2.	ca. 56	ca. 133
2BH1400-7..0.	ca. 30	ca. 86
2BH1400-7..1.	ca. 50	ca. 122
2BH1400-7..2.	ca. 75	ca. 167
2BH1430-7..0.	ca. 27	ca. 81
2BH1430-7..1.	ca. 51	ca. 124
2BH1430-7..2.	ca. 77	ca. 171
2BH1500-7..0.	ca. 22	ca. 72
2BH1500-7..1.	ca. 36	ca. 97
2BH1500-7..2.	ca. 50	ca. 122
2BH1500-7..3.	ca. 82	ca. 180
2BH1500-7..6.	ca. 120	ca. 248
2BH1530-7..0.	ca. 23	ca. 73
2BH1530-7..1.	ca. 33	ca. 91
2BH1530-7..2.	ca. 65	ca. 149
2BH1530-7..3.	ca. 100	ca. 212
2BH1530-7..6.	ca. 100	ca. 212
2BH1600-7..0.	ca. 20	ca. 68
2BH1600-7..1.	ca. 40	ca. 104
2BH1600-7..2.	ca. 80	ca. 176
2BH1600-7..3.	ca. 85	ca. 185
2BH1600-7..6.	ca. 90	ca. 194
2BH1600-7..7.	ca. 120	ca. 248
2BH1630-7..0.	ca. 30	ca. 86
2BH1630-7..1.	ca. 55	ca. 131
2BH1630-7..2.	ca. 70	ca. 158
2BH1630-7..3.	ca. 107	ca. 225
2BH1630-7..6.	ca. 107	ca. 225
2BH1630-7..7.	ca. 107	ca. 225
2BH180.-7..0.	ca. 40	ca. 104
2BH180.-7..1.	ca. 85	ca. 185
2BH180.-7..2.	ca. 105	ca. 221
2BH1830-7..2.	ca. 70	ca. 158
2BH190.-7..0.	ca. 35	ca. 95
2BH190.-7..1.	ca. 68	ca. 155
2BH190.-7..3.	ca. 100	ca. 212
2BH1930-7..3.	ca. 89	ca. 192

Two-impeller design (at a frequency of 50 Hz)		
Type	Temperature increase	
	ΔT [K]	$\Delta \theta$ [F]
2BH1310-7..2.	approx. 53	approx. 127
2BH1410-7..3.	approx. 68	approx. 154
2BH1410-7..4.	approx. 83	approx. 181
2BH1510-7..4.	approx. 88	approx. 190
2BH1510-7..5.	approx. 90	approx. 194
2BH1610-7..1.	approx. 33	approx. 92
2BH1610-7..2.	approx. 54	approx. 129

Two-impeller design (at a frequency of 50 Hz)		
Type	Temperature increase	
	ΔT [K]	Δθ [F]
2BH1610-7..3.	approx. 80	approx. 176
2BH1610-7..4.	approx. 105	approx. 221
2BH1610-7..5.	approx. 120	approx. 248
2BH1610-7..7.	approx. 80	approx. 176
2BH1610-7..8.	approx. 80	approx. 176
2BH1640-7..3.	approx. 20	approx. 68
2BH1640-7..4.	approx. 35	approx. 95
2BH1640-7..5.	approx. 44	approx. 111
2BH1640-7..8.	approx. 20	approx. 68
2BH181.-7..1.	approx. 45	approx. 113
2BH181.-7..2.	approx. 85	approx. 185
2BH181.-7..3.	approx. 120	approx. 248
2BH181.-7..4.	approx. 135	approx. 275
2BH184.-7..2.	approx. 45	approx. 113
2BH184.-7..3.	approx. 80	approx. 176
2BH191.-7..1.	approx. 48	approx. 119
2BH191.-7..2.	approx. 95	approx. 203
2BH191.-7..3.	approx. 120	approx. 248
2BH1943-7..2.	approx. 32	approx. 90
2BH1943-7..3.	approx. 60	approx. 140
2BH1943-7..4.	approx. 100	approx. 212

Two-impeller design (at a frequency of 60 Hz)		
Type	Temperature increase	
	ΔT [K]	Δθ [F]
2BH1310-7..2.	approx. 74	approx. 165
2BH1410-7..3.	approx. 65	approx. 149
2BH1410-7..4.	approx. 82	approx. 180
2BH1510-7..4.	approx. 80	approx. 176
2BH1510-7..5.	approx. 94	approx. 201
2BH1610-7..1.	approx. 30	approx. 86
2BH1610-7..2.	approx. 48	approx. 118
2BH1610-7..3.	approx. 75	approx. 167
2BH1610-7..4.	approx. 88	approx. 190
2BH1610-7..5.	approx. 130	approx. 266
2BH1610-7..7.	approx. 75	approx. 167
2BH1610-7..8.	approx. 120	approx. 248
2BH1640-7..3.	approx. 25	approx. 77
2BH1640-7..4.	approx. 30	approx. 86
2BH1640-7..5.	approx. 42	approx. 108
2BH181.-7..2.	approx. 60	approx. 140
2BH181.-7..3.	approx. 120	approx. 248
2BH181.-7..4.	approx. 130	approx. 266
2BH184.-7..2.	approx. 30	approx. 86
2BH184.-7..3.	approx. 70	approx. 158
2BH191.-7..1.	approx. 46	approx. 115
2BH191.-7..2.	approx. 76	approx. 169
2BH191.-7..3.	approx. 134	approx. 274
2BH1943-7..2.	approx. 30	approx. 86
2BH1943-7..3.	approx. 45	approx. 113
2BH1943-7..4.	approx. 65	approx. 149

Tightening torques for screw connections

The following values apply if no other information is available.

With non-electrical connections, property classes of 8.8 and 8 or higher as per DIN ISO 898 (DIN EN 20898 / DIN ISO 898) are assumed.

 Thread	Tightening torques for non-electrical connections	
	[Nm]	[ft lbs]
M4	3 ± 0.3	2.21 ± 0.22
M5	4 ± 0.4	2.95 ± 0.3
M6	8 ± 0.8	5.9 ± 0.59
M8	24 ± 2.4	17.7 ± 1.77
M10	42 ± 4.2	31 ± 3.1
M12	70 ± 7.0	51.6 ± 5.16

The following information for electrical connection applies to all terminal board connections with the exception of terminal strips.

 Thread	Tightening torques for electrical connections	
	[Nm]	[ft lbs]
M4	0.8 - 1.2	0.59 - 0.89
M5	1.8 - 2.5	1.33 - 1.84

Especially for metal and plastic threaded cable glands and pipe unions, the following values apply:

 Thread	Tightening torques for metal threaded glands/unions			
	[Nm]		[ft lbs]	
	min	max	min	max
M12x1.5	4	6	2.95	4.43
M16x1.5	5	7.5	3.69	5.53
M20x1.5	6	9	4.43	6.64
M32x1.5	8	12	5.9	8.85
M40x1.5				

 Thread	Tightening torques for plastic threaded glands/unions			
	[Nm]		[ft lbs]	
	min	max	min	max
M12x1.5	2	3.5	1.48	2.58
M16x1.5	3	4	2.21	2.95
M20x1.5	4	5	2.95	3.69
M32x1.5	5	7	3.69	5.16
M40x1.5				

3.2 Electrical data

See rating plate.

3.3 Operating conditions

Temperatures

Temperature of pumped gases:	max. permissible temperature: +40 °C [+104 °F] Nominal value: +15 °C [+59 °F] Pump-motor units for higher fluid temperatures on request.
Ambient temperature:	max. permissible temperature: +40 °C [+104 °F] min. permissible temperature: -30 °C [-22 °F] Nominal value: +25 °C [+77 °F] Ambient temperatures between 25 °C [+77 °F] and 40 °C [+104 °F] affect the permissible total pressure difference (see Section "Permissible total pressure difference"). At higher temperatures the winding may be damaged and the grease change interval may be shortened.

Pressures

Min. inlet pressure:	See rating plate.
Max. discharge pressure during compressor operation:	See rating plate.
Max. permissible pressure in pump-motor unit:	2 bar abs. [29 psia] At this pressure the operation of the pump-motor unit may be considerably impaired. Provide a corresponding protective device (e.g. pressure relief valve) if necessary.

Permissible total pressure difference:	The total pressure difference specified on the rating plate only applies under the following conditions: <ul style="list-style-type: none"> Ambient temperature: 25°C [77 °F]. Inlet temperature (temperature of pumped gases at inlet connection): 15°C [59 °F]. Pressure: <ul style="list-style-type: none"> during vacuum-pump operation: 1,013 mbar [14.7 psia] at discharge connection; during compressor operation: 1,013 mbar [14.7 psia] at inlet connection; At an ambient temperature of 40 °C [104 °F] the total pressure difference specified on the rating plate must be reduced by 10%. If the ambient temperature is between 25 °C [77 °F] and 40 °C [104 °F], then the total pressure difference specified on the rating plate must be reduced.
--	---

Installation altitude

Max. of 1,000 m [3,280 ft] above sea level. When installing the pump-motor unit at an altitude of more than 1,000 m [3,280 ft] above sea level, first inquire with the Service department.

4 Transport and Handling

 WARNING
<p>Tipping or falling can lead to crushing, broken bones etc.! Sharp edges can cause cuts! Wear personal safety equipment (gloves, safety shoes and protective helmet) during transport!</p>

 WARNING
<p>Danger from tipping or falling loads! Prior to transport and handling make sure that all components are securely assembled and secure or remove all components the fasteners of which have been loosened!</p>

Manual handling:

 WARNING
<p>Danger from lifting heavy loads! Manual handling of the unit is only permitted within the following limits:</p> <ul style="list-style-type: none"> • max. 30 kg [max. 66 lbs] for men • max. 10 kg [max. 22 lbs] for women • max. 5 kg [max. 11 lbs] for pregnant women <p>For the weight of the pump-motor unit, see Chapter 3.1, "Mechanical data", Section "Weight", Pg. 7. For weights above the given values use suitable lifting appliances and handling equipment!</p>

Handling by means of lifting equipment:

 WARNING
<p>Danger from tipping or falling loads! When transporting with lifting equipment, observe the following basic rules:</p> <ul style="list-style-type: none"> • The lifting capacity of lifting equipment and lifting gear must be at least equal to the unit's weight. For the weight of the pump-motor unit, see Chapter 3.1, "Mechanical data", Section "Weight", Pg. 7. • The pump-motor unit must be secured so that it cannot tip or fall. • Do not stand or walk under suspended loads!

The transport must be carried out in different ways depending on the type:

- 2BH11., 2BH12., 2BH13., 2BH14., 2BH15. (single-impeller): Manual handling
- 2BH15. (two-impeller), 2BH16., 2BH18., 2BH19.:
Transport with crane, hooked onto eye bolt (1 attachment point)
- 2BH1943:
Transport with crane, hooked with lifting belts onto eye bolt and onto the holes in the two feet of the vacuum pump/compressor housing (3 attachment points).

For **transport with a crane**, the pump-motor unit can be hooked into the crane hook as follows:

- directly on the eye bolt
(With 2BH194 the eye bolt and the two foot holes should be used)

or possibly

- with lifting belts.

Eye bolt:

Types with a weight of up to 30 kg [66 lbs] are **not** equipped with an eye bolt (2BH11., 2BH12., 2BH13., 2BH14., 2BH15 [single-impeller]).

Types with a weight of more than 30 kg [66 lbs] are equipped with an eye bolt as **standard** (2BH15. [two-impeller], 2BH16., 2BH18., 2BH19.).

The eye bolt is mounted on the vacuum pump/compressor housing.

In case of possible removal and remounting of the eye bolt, it must be ensured that the eye level is positioned exactly in the axis direction of the pump-motor unit. Lay shims under the eye bolt if necessary.

The eye bolt must be firmly tightened.

Loads laterally to the ring level are not permissible. Heavy impact loads during transport must be avoided.

5 Installation

 WARNING
<p>Improper use of the unit can result in serious or even fatal injuries! Have you read the safety precautions in Chapter 1, "Safety", Pg. 3 f.? Otherwise you may not carry out any work with or on the pump-motor unit!</p>

 DANGER
<p>Danger from missing view into area of pump-motor unit! When operating the control elements without a view into the area of the pump-motor unit, there is a danger that the pump-motor unit will be switched on while other persons are still performing work on it. Extreme injuries are possible! Provide control elements at a location with a view of the pump-motor unit.</p>

 DANGER
<p>Electrical danger! The pump-motor unit must be installed so that the electrical device cannot be damaged by external influences! In particular, the feed pipes must be securely routed, e.g. in cable ducts, in the floor etc.</p>

⚠ WARNING**Danger from balance damage caused by vibration!**

Vibrating environments can cause balance damage!

Install the pump-motor unit on a solid foundation or on a solid mounting surface.

Check screw glands/unions for mounting the pump-motor unit on the mounting surface regularly for strength and firm seating.

⚠ WARNING**Danger from crushing due to pump-motor unit tipping over!**

Wear personal safety equipment (protective gloves and safety shoes). Handle the unit with the appropriate care. Install the pump-motor unit on a solid foundation or on a solid mounting surface! Check screw glands/unions for mounting the pump-motor unit on the mounting surface regularly for strength.

⚠ WARNING**Danger of fire from flammable substances!**

The pump-motor unit must never come into contact with flammable substances.

For exact information on the temperature increase, see Chapter 3.1, "Mechanical data", Section "Temperature increase", Pg. 9.

⚠ WARNING**Danger of burns from hot surfaces of the pump-motor unit and from hot fluids!**

High temperatures of up to approx. 160°C [320 °F] can occur on the surface of the pump-motor unit.

The pump-motor unit must be installed so that accidental touch of its surface is not possible. Cover the pump-motor unit with a suitable touch protection (e.g. perforated plate cover or wire cover).

⚠ WARNING**Danger of injuries from flying parts!**

Select installation so that parts that are thrown out through the grate if the external fan breaks cannot hit persons!

⚠ CAUTION**Danger of tripping and falling!**

Make sure the unit does not present a danger of tripping. Lay cables and pipes so that they cannot be reached during operation (recessed in floor, in ducts on the wall etc.).

CAUTION**Danger of overheating due to hot surface of pump-motor unit!**

High temperatures can occur on the surface of the pump-motor unit.

Temperature sensitive parts, such as lines or electronic components, may not come into contact with the surface of the pump-motor unit.

The pump-motor unit is ready to connect on delivery. However, if the time from delivery to commissioning of the pump-motor unit exceeds a certain period, the lubrication of the rolling bearings must be renewed. See Chapter 8.2, "Storage conditions", Section "Lubrication of rolling bearings after longer storage", Pg. 22 for information on this topic.

Carry out the following work to install the pump-motor unit:

- Installation and securing,
- Attachment of the included loose muffler if necessary,
- Attachment of threaded flange or hose flange (available as accessories) for the connection of inlet or discharge pipe to the muffler,
- Electrical connection,
- Connection of inlet and discharge connection to the system.

5.1 Installation**⚠ WARNING**

For an installation that differs from the following specifications, it is necessary to inquire with the Service Department!

Ambient conditions:

The pump-motor unit is suitable for installation in the following environments:

- In a dusty or damp environment,
- in buildings,
- in the open.
When properly installed in the open, the pump-motor unit must be protected from exposure to intensive sunlight, e.g. by attaching a protective roof. Otherwise, no special protective devices against the effects of weathering are required.

The drive motors of the pump-motor units have the following design:

- with degree of protection IP55 (see rating plate),
- with tropicalized insulation.

Installation conditions:

The pump-motor unit must be installed as follows:

- on level surfaces,
- at a maximum height of 1000 m [3280 ft] above sea level.
When installing at an altitude of more than 1,000 m [3,280 ft] above sea level, first inquire with the Service Department.

Minimum distances:

To ensure sufficient cooling of the pump-motor unit, it is absolutely necessary that the required minimum distances to the **fan guard** and to the **face of the vacuum pump/compressor cover** be maintained. see Chapter 3.1, "Mechanical data", Section "Minimum distances", Pg. 7.

The minimum distances to the face of the vacuum pump/compressor cover are especially important when installing on the vacuum pump/compressor cover or near a wall.

CAUTION

To ensure sufficient cooling of the pump-motor unit, also observe the following:

- Ventilation screens and openings must remain clear.
- Discharge air of other units may not be directly sucked in again!

Noise radiation:

To reduce the noise radiation, the following must be observed:

- Do not mount pump-motor unit on noise-conducting or noise-radiating parts (e.g. thin walls or sheet-metal plates).
- Provide pump-motor unit with sound-insulating intermediate layers (e.g. rubber buffers under the base of the pump-motor unit) if necessary.
- Install the pump-motor unit on a stable foundation or on a rigid mounting surface. This provides for smooth, low-vibration running of the pump-motor unit.

Components for reducing noise on the pump-motor unit:

- **Mufflers** (included as standard equipment):
On delivery the pump-motor units are equipped with attached mufflers as standard. The noise radiation is considerably reduced by the mufflers. See Fig. 2 to Fig. 9, Pg. 17 ff.
- **Additional mufflers** (available as an option):
The additional mufflers enable a further noise reduction. They may only be used with free entry and exit of gases, i.e. with direct intake out of or direct feeding into the atmosphere **without piping**.
- **Noise protection hoods** (available as an option):
Noise protection hoods are suitable for installation in rooms and in the open. They reduce both the total sound pressure level and tonal components that are perceived as particularly annoying.

Installation variants/axis position:

Basically, when installing the pump-motor unit, the following variants are possible with a different axis position (horizontal or vertical):

- Horizontal installation
- Vertical installation on the vacuum pump/compressor cover ("cover installation")
- Vertical mounting on the wall

Basically, all variants are possible with all type.

Exception:

With type 2BH1943 vertical installation on the vacuum pump/compressor cover ("cover installation") is mandatory.

In addition, a distinction must be made between a design with and a design without a **condensed water opening** for the axis position:

- The pump-motor units without a condensed water opening can be installed and secured in any axis position.
- The pump-motor unit with a condensed water opening may only be installed and secured horizontally with the base at the bottom.

Horizontal installation

Screw the base of the pump-motor unit to the surface with suitable mounting elements. Proceed as follows:

- Provide the base of the pump-motor unit with mounting holes.

- Select the suitable screw type.
- Screw the base of the pump-motor unit to the surface with the screws. When doing so, be sure to provide **all** mounting holes with screws!

Vertical installation on the vacuum pump/compressor cover ("cover installation")

With vertical installation of the pump-motor unit with the vacuum pump/compressor cover facing downward, rubber feet must be used.

Proceed as follows:

- The rubber feet are available as accessories. They are delivered in a set of 3. On the upper section they are provided with stud bolts and on the lower section with a threaded hole.
- Mount the rubber feet on the pump-motor unit:
Screw the stud bolts of the rubber feet into the holes on the face of the vacuum pump/compressor cover and tighten them.
- Mount the pump-motor unit together with the rubber feet on the installation surface:
Select suitable mounting elements for the threaded hole. Screw the rubber feet to the surface or foundation via the threaded hole.

Vertical mounting on the wall

With vertical mounting of the pump-motor unit on the wall, the pump-motor unit is mounted via the holes in the base.

Proceed as follows:

- Position the pump-motor unit as close to the wall as possible on a stable supporting plate with sufficient load-bearing capacity. The pump-motor unit must be positioned with the base toward the wall.
- Provide the base of the pump-motor unit with mounting holes.
- Select the suitable screw type.
- Screw the base of the pump-motor unit to the wall with the screws.
When doing so, be sure to provide **all** mounting holes with screws!
- Remove the supporting plate.

Eye bolt:

Following installation the eye bolt can be removed.

5.2 Electrical connection (motor)

DANGER

Electrical danger!

Malpractice can result in severe injuries and material damage!

DANGER

Electrical danger!

The electrical connection may be carried out by trained and authorized electricians only!

DANGER

Electrical danger!

Before beginning work on the unit or system, the following measures must be carried out:

- Deenergize.
- Secure against being switched on again.
- Determine whether deenergized.
- Ground and short-circuit.
- Cover or block off adjacent energized parts.

CAUTION

Incorrect connection of the motor can lead to serious damage to the unit!

Regulations:

The electrical connection must be carried out as follows:

- according to the applicable national and local laws and regulations,
- according to the applicable system-dependent prescriptions and requirements,
- according to the applicable regulations of the utility company.

Electrical power supply:

Observe the **rating plate**.

It is imperative that the operating conditions correspond to the data given on the rating plate!

Deviations permissible without reduction in performance:

- ± 5 % voltage deviation
- ± 2 % frequency deviation

Connection to drive-motor terminal box:

Open the required cable entry openings on the terminal box. Here the following two cases are differentiated:

- The cable entry opening is prefabricated and provided with a sealing plug.
- Screw out sealing plug.

OR

- The cable entry opening is closed off with a casting skin (only on pump-motor units with drive-motor axis heights of 100 to 160 in standard design).
- Break out casting skin using a suitable tool. For example, use a metal pin with a corresponding diameter or a chisel and hammer.

CAUTION
<p>When pounding out the casting skin on the cable entry openings in the terminal box, the terminal box or its parts can be damaged (e.g. terminal board, cable connections). Proceed with suitable caution and precision when doing so! Prevent flash formation!</p>

Mount cable glands on the terminal box. Proceed as follows:

- Select one cable gland in each case which is suitable for the cable diameter.
- Insert this cable gland in the opening of the terminal box. Use a reducer if necessary.
- Screw on the cable gland so that no moisture, dirt etc. can penetrate into the terminal box.

Carry out the connection and the arrangement of the jumpers in accordance with the **circuit diagram in the terminal box**.

Connect the protective conductor to the terminal with the following symbol:



The electrical connection must be carried out as follows:

- The electrical connection must be permanently safe.
- There may be no protruding wire ends.
- Clearance between bare live parts and between bare live parts and ground: $\geq 5.5 \text{ mm [0.217"]}$ (at a nominal voltage of $U_N \leq 690\text{V}$).

- For the tightening torques for terminal board connections (except terminal strips), see Chapter 3.1, "Mechanical data", Section "Tightening torques for screw connections", Pg. 10.
- For terminals with clamping straps (e.g. as per DIN 46282), the conductors must be inserted so that approximately the same clamping height results on both sides of the bar. Individual conductors must therefore be bent into a U-shape or connected with a cable lug (DIN 46234).

This also applies to:

- the protective conductor,
- the outer ground conductor.

Both conductors can be recognized from their color (green/yellow).

⚠ DANGER
<p>Electrical danger! The terminal box must be free from</p> <ul style="list-style-type: none"> • foreign bodies, • dirt, • humidity. <p>Terminal box cover and cable entries must be tightly closed so as to make them dustproof and waterproof. Check for tightness at regular intervals.</p>

⚠ DANGER
<p>Electrical danger! Clearance between bare live parts and between bare live parts and ground: at least 5.5 mm [0.217"] (at a nominal voltage of $U_N \leq 690\text{V}$). There may be no protruding wire ends!</p>

For **motor overload protection**:

- Use motor circuit breakers.
- This must be adjusted to the specified nominal current (see rating plate).

⚠ DANGER
<p>Electrical danger! There is danger of an electrical shock when a defective pump-motor unit is touched! Mount motor circuit breaker. Have electrical equipment checked regularly by an electrician.</p>

Interference immunity of drive motor:

For drive motors with integrated sensors, the operator must provide for a sufficient

interference immunity itself. Select a suitable sensor signal cable (e.g. with screening, connection as for a motor power-supply cable) and analyzing unit.

Operation with frequency converter:

With a power supply by a frequency converter, the following must be observed:

- High-frequency current and voltage harmonics in the motor supply cables can lead to emitted electromagnetic interference. This is dependent on the converter design (type, manufacturer, interference suppression measures).
- Be sure to observe the EMC notes of the converter manufacturer!
- Use screened power supply cables if necessary. For optimal screening, the screen must be conductively connected over a large area to the metal terminal box of the drive motor with a screwed metal gland.
- In the case of drive motors with integrated sensors (e.g. PTC thermistors) interference voltage can occur on the sensor cable depending on the converter type.
- Limit speed:
see specifications on the rating plate.

 WARNING
Pump-motor units with a UL approbation may not be operated on frequency converters in the US without testing by a suitable test agency!

5.3 Connecting pipes/hoses (vacuum pump/compressor)

Mufflers:

The pump-motor units are delivered with mufflers (indicated with arrows in the following illustrations) for the inlet and discharge connections as standard equipment.

On delivery the mufflers are already mounted on the following pump-motor units.

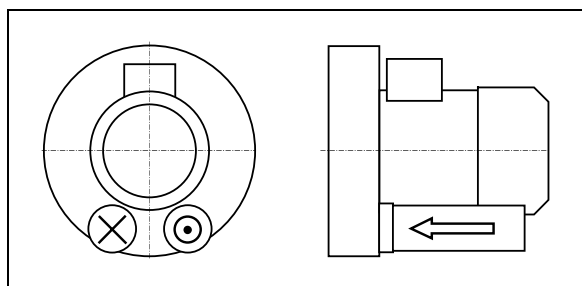

Fig. 2: 2BH1100 ... 2BH1930 (single-impeller

pump-motor units)

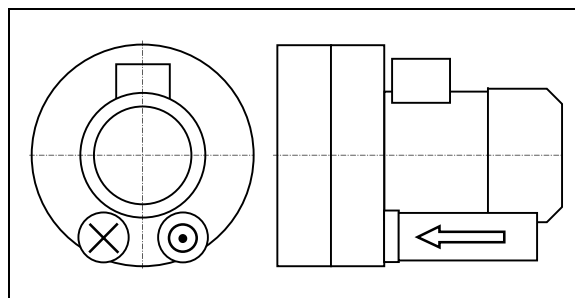

Fig. 3: 2BH1640 (two-impeller pump-motor unit with double-flow design)

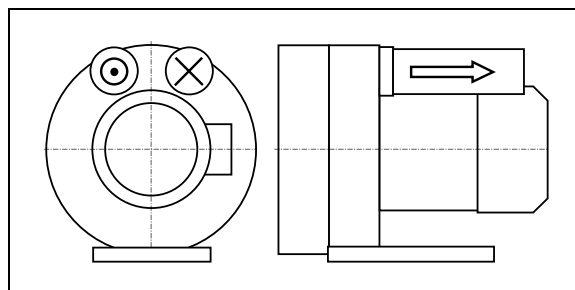

Fig. 4: 2BH1840-7G... (two-impeller pump-motor unit with double-flow design)

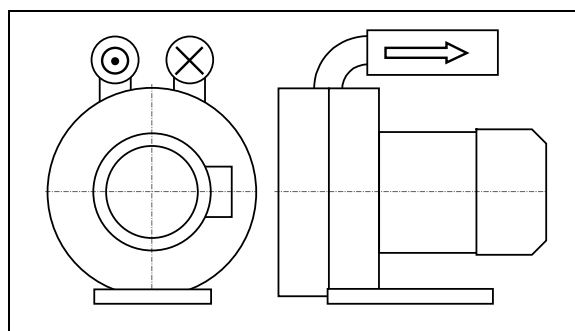

Fig. 5: 2BH1840-7J... (two-impeller pump-motor unit with double-flow design)

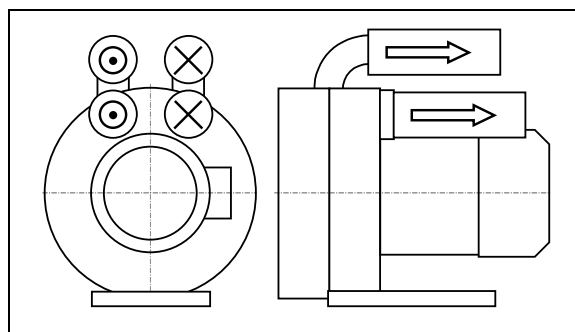

Fig. 6: 2BH1840-7L... (two-impeller pump-motor unit with double-flow design)

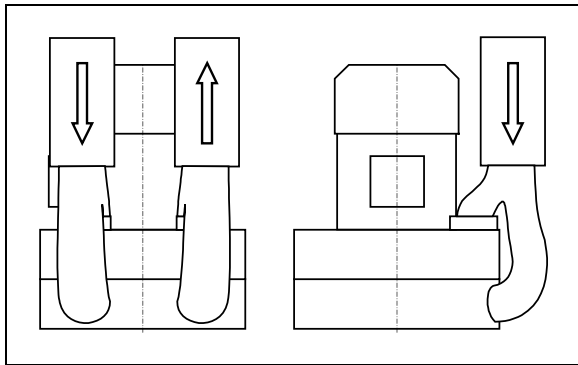

Fig. 7: 2BH1943 (two-impeller pump-motor unit with double-flow design)

On two-impeller pump-motor units with a two-stage design of the types 2BH1310 to 2BH1910 the discharge-side muffler is included loose for packing-related reasons and must be mounted by the customer.

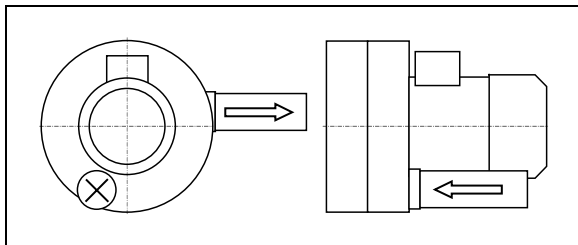

Fig. 8: 2BH1310 ... 2BH1610, 2BH1910 (two-impeller pump-motor units with a two-stage design)

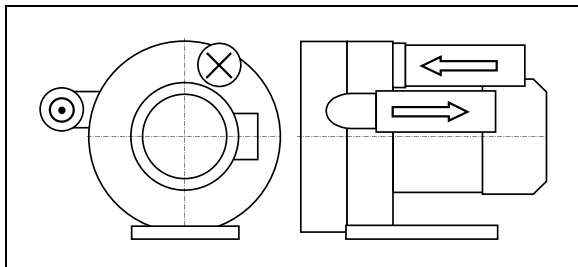

Fig. 9: 2BH1810 (two-impeller pump-motor unit with a two-stage design)

⚠ WARNING

**Danger from rotating impeller:
Cutting/cutting of off extremities!**

The rotating impeller is accessible with the inlet and discharge connections open!

With free entry and exit of gases, i.e. with direct intake out of or direct feeding into the atmosphere without piping, the following therefore applies:

Provide the inlet and discharge connections of the pump-motor unit either with additional mufflers or with additional piping of a sufficient length to prevent access to the impeller!

Connections:

To prevent foreign bodies from entering the unit, all connections are sealed off when delivered. Do not remove the sealing plugs until immediately before connecting the pipes/hoses.

The following applies for the arrangement of the pipe/hose connections:

The **pumped gases** are sucked in via the inlet connection (see Chapter 5.3.1, Pg. 19) and discharged via the discharge connection (see Chapter 5.3.2, Pg. 19).

The **shaft rotating direction** is marked with an arrow on the back of the vacuum pump/compressor housing (Fig. 1, Pg. 2, Item 7).

The **delivery direction of the gases** is marked with arrows on both connections (Fig. 1, Pg. 2, Item 6).

⚠ WARNING

Danger from interchanging inlet and pressure line!

Interchanged inlet and pressure lines can lead to damage to the pump-motor unit and the system, and as a result of this to serious injuries!

Make sure that the inlet and pressure line cannot be confused when connecting.

Look for the clear marking with the arrow indicating the delivery direction on the inlet and discharge connections.

⚠ WARNING**Danger due to vacuum and gauge pressure!****Danger due to escaping fluid!**

During operation, connected pipes and vessels are vacuumized or pressurized!

Use only mounting elements, connections, lines, fittings and containers with sufficient freedom from leaks and strength for the pressures which occur.

Make sure that the mounting elements and connections are mounted sufficiently firmly and leak-free!

CAUTION

If the pumped gases are passed on on the discharge side in a closed pipe system, then it must be ensured that the pipe system is adapted to the maximum discharge pressure. See Chapter 3.3: "Operating conditions", Section "Pressures", Pg. 11. Connect a pressure relief valve upstream if necessary.

NOTICE

Attach pipes/hoses free of mechanical tensions. Support the weight of the pipes/hoses.

5.3.1 Inlet connection

The inlet connection with the related muffler (Fig. 1, Pg. 2, Item 3) is marked with an arrow pointing into the vacuum pump/compressor. Connect the inlet pipe here. The pumped gases are sucked in via this. Procedure: see Chapter 5.3.3.

⚠ WARNING**Danger from solid bodies and impurities in the pump-motor unit!**

If solid bodies penetrate into the pump-motor unit, blades of the impellers can break and broken pieces can be thrown out.

Install a filter in the inlet pipe.
Replace filter regularly!

5.3.2 Discharge connection

The discharge connection with the related muffler (Fig. 1, Pg. 2, Item 4) is marked with an arrow pointing out of the vacuum pump/compressor. Connect the discharge pipe here. The pumped gases are discharged via this. Procedure: see Chapter 5.3.3.

5.3.3 Procedure when connecting pipes/hoses

Attach the pipes/hoses to the unit as described in the following. The pipes/hoses are connected differently to inlet and discharge connections depending on the muffler design and the type of line (pipe or hose):

- Muffler with inside threads:
The pipe is screwed directly into the muffler.
- Muffler without inside thread:
 - Screw threaded flange (available as an accessory) onto the muffler.
 - Screw the pipe into the threaded flange.
- Hose connection:
 - Screw hose flange (available as an accessory) onto the muffler.
 - Push the hose onto the hose flange and secure it with a hose clamp. See Chapter 3.1, "Mechanical data", Section "Tightening torques for screw connections", Pg. 10 for information on this topic.

6 Commissioning**⚠ WARNING****Improper use of the unit can result in serious or even fatal injuries!**

Have you read the safety precautions in Chapter 1, "Safety", Pg. 3 f.? Otherwise you may not carry out any work with or on the pump-motor unit!

⚠ WARNING**Danger from rotating parts (external fan, impeller, shaft): Cutting/cutting off of extremities, Grasping/winding up of hair and clothing!****Danger due to vacuum and gauge pressure: sudden escape of fluids (skin and eye injuries), sudden drawing in of hair and clothing!****Danger due to escaping fluid: Burns!**

Start-up and operation only under the following conditions:

- The pump-motor unit must be completely assembled. When doing so, pay particular attention to the following components:
 - the vacuum pump/compressor cover,
 - the muffler on inlet and discharge connections,
 - the fan guard.
- The pipes/hoses must be connected to inlet and discharge connections.
- Inlet and discharge connections and the connected pipes/hoses may not be closed, clogged or soiled.
- Check the mounting elements, connections of the pipe/hose connections, lines, fittings and containers for strength, leaks and firm seating at regular intervals.

6.1 Preparation

 WARNING
<p>Danger from closed connections!</p> <p>With closed/soiled intake or discharge connections vacuum or gauge pressure results in the pump-motor unit.</p> <p>This can overheat and damage the drive motor winding.</p> <p>Before start-up, make sure that the inlet and discharge connections are not closed, clogged or soiled!</p>

CAUTION
<p>Before starting up again after a longer standstill:</p> <p>Measure the insulation resistance of the motor. With values ≤ 1 kΩ per volt of nominal voltage, the winding is too dry.</p>

Measures before start-up:

- If a shut-off device is installed in the discharge pipe:
Make sure that the unit is NOT operated with the shut-off device closed.
- Before starting up the pump-motor unit, observe the values specified on the rating plate. Specifications on the drive-motor nominal current apply at a gas entry and ambient temperature of +40° C [104 °F].
- Adjust the motor circuit breaker to the drive-motor nominal current.

Check direction of rotation:

- The intended rotating direction of the shaft is marked with arrows on the vacuum pump/compressor housing (Fig. 1, Pg. 2, Item. 7).
- The gas delivery direction is marked with arrows on the inlet and discharge connections (Fig. 1, Pg. 2, Item 6).
- Make sure the pipes/hoses on the inlet and discharge connections are properly connected.
- Switch the pump-motor unit on briefly and then off again.
- Compare the actual rotating direction of the external fan with the intended shaft rotating direction indicated with the arrows shortly before the pump-motor unit comes to a standstill.
- If necessary, reverse the direction of rotation of the motor.

 WARNING
<p>Danger due to rotating parts! Danger due to vacuum and gauge pressure! Danger due to escaping fluid!</p> <p>Test runs may also only be conducted with the pump-motor unit completely mounted.</p>

 DANGER
<p>Electrical danger!</p> <p>The electrical connection may be carried out by trained and authorized electricians only!</p>

 DANGER
<p>Electrical danger!</p> <p>Before beginning work on the unit or system, the following measures must be carried out:</p> <ul style="list-style-type: none"> • Deenergize. • Secure against being switched on again. • Determine whether deenergized. • Ground and short-circuit. • Cover or block off adjacent energized parts.

Check operating speeds:

Observe the operating speed specified on the rating plate. This may not be exceeded, as otherwise the noise radiation, vibration behavior, grease consumption duration and bearing change interval worsen. To prevent damage as a result of higher speeds, it may be necessary to inquire with the Service Department as to the maximum speed.

 WARNING
<p>Danger of hearing damage due to noise radiation!</p> <p>For the noise emission of the pump-motor unit measured by the manufacturer, see Chapter 3.1, "Mechanical data", Section "Noise level", Pg. 8. However, the actual noise emission during operation is highly dependent on the installation and system conditions. Conduct a noise measurement in the system during operation after installing the pump-motor unit. The following measures can be taken from 85 dB(A) and must be taken from 90 dB(A):</p> <ul style="list-style-type: none"> • Mark noise area with a warning sign. • Wear hearing protection. • With free entry and exit of gases, i.e. with direct intake out of or direct feeding into the atmosphere without piping, attach an additional muffler.

6.2 Start-up and shut-down

Start-up

- Open shut-off device in intake/discharge pipe.

- Switch on power supply for drive motor.

Shut-down:

- Switch off power supply for drive motor.
- Close shut-off device in intake/discharge pipe.

7 Operation

⚠ WARNING

Improper use of the unit can result in serious or even fatal injuries!
 Have you read the safety precautions in Chapter 1, "Safety", Pg. 3 f.?
 Otherwise you may not carry out any work with or on the pump-motor unit!
 Also **be sure** to read the safety precautions in Chapter 6, "Commissioning", Pg. 19!

Starting up and shutting down

See Chapter 6, "Commissioning", Sub-Chapter 6.2, "Start-up and shut-down", Pg. 20. Also be sure to observe the following important notes especially for operation:

⚠ WARNING

Danger of burns from hot surfaces of the pump-motor unit and from hot fluids!
 High temperatures of up to approx. 160°C [320 °F] can occur on the surface of the pump-motor unit.
 Do not touch during operation!
 Allow to cool after shut-down!

CAUTION

Danger of overheating due to hot surface of pump-motor unit!
 High temperatures of up to approx. 160°C [320 °F] can occur on the surface of the pump-motor unit.
 Temperature sensitive parts, such as lines or electronic components, may not come into contact with the surface of the pump-motor unit.

CAUTION

Danger of overheating!
 During operation the standstill heating may, if installed, **not** be switched on!

CAUTION

Danger of rusting due to collection of condensed water in drive motor area!
 On drive motors with closed condensed water openings:
 Remove closures occasionally to allow any water which has collected to drain off.

CAUTION

Danger of bearing damage!
 Heavy mechanical impacts must be avoided during operating and while at a standstill.

8 Shut-Down and Longer Standstills

8.1 Preparing for shut-down or longer standstill

⚠ WARNING

Improper use of the unit can result in serious or even fatal injuries!
 Have you read the safety precautions in Chapter 1, "Safety", Pg. 3 f.?
 Otherwise you may not carry out any work with or on the pump-motor unit!

CAUTION

Danger of rusting due to collection of condensed water in drive motor area!
 On drive motors with closed condensed water openings:
 Remove closures occasionally to allow any water which has collected to drain off.

CAUTION

Danger of bearing damage!
 Heavy mechanical impacts must be avoided during operating and while at a standstill.

Prior to shut-down or longer standstill, proceed as follows:

- Switch off the pump-motor unit.
- Close shut-off device in inlet and pressure line if installed.
- Disconnect pump-motor unit from power supply.
- Release pressure.
 When doing so, open pipes/hoses slowly and carefully so that the vacuum or gauge pressure in the pump-motor unit can be released.
- Remove pipes/hoses.

- Provide mufflers on inlet and discharge side with sealing plugs.

8.2 Storage conditions

To prevent standstill damage during storage, the environment must provide the following conditions:

- dry,
- dust-free,
- low-vibration ($V_{eff} \leq 2,8 \text{ mm/s}$ [0,11"/sec]).
- Ambient temperature: max. 40 °C [+104 °F].

CAUTION
<p>Danger of overheating due to high temperature!</p> <p>When storing in an environment with a temperature of over 40 °C [104 °F], the winding may be damaged and the grease change interval may be shortened.</p>

Lubrication of rolling bearings after longer storage:

The new pump-motor unit may at first be stored following delivery. If the time from deliver to commissioning exceeds the following periods, the lubrication of the rolling bearings must be renewed:

- Under advantageous storage conditions (as specified above): 4 years.
- Under disadvantageous storage conditions (e.g. high humidity, salty air, sandy or dusty air): 2 years.

In these cases open rolling bearings must be relubricated and closed rolling bearings must be completely replaced. In this case be sure to inquire with the Service Department. In particular, exact information with regard to the procedure and grease type are required.

9.1 Repairs/troubleshooting

Fault	Cause	Remedy	Carried out by
Motor does not start; no motor noise.	At least two power supply leads interrupted.	Eliminate interruption by fuses, terminals or power supply cables.	Electrician
Motor does not start; humming noise..	One power supply lead interrupted.	Eliminate interruption by fuses, terminals or power supply cables.	Electrician
	Impeller is jammed.	Open vacuum pump/compressor cover, remove foreign body, clean.	Service*)
		Check or correct impeller gap setting if necessary.	Service

⚠ WARNING
<p>Improper use of the unit can result in serious or even fatal injuries!</p> <p>All maintenance work on the pump-motor unit must always be performed by the Service Department!</p> <p>Maintenance work on the pump-motor unit may only be conducted by the operator itself when the related maintenance manual on hand!</p> <p>Inquire with the Service Department!</p>

Commissioning after longer standstill:

Before recommissioning after a longer standstill, measure the insulation resistance of the drive motor. With values $\leq 1 \text{ k}\Omega$ per volt of nominal voltage, the winding is too dry.

9 Servicing

⚠ WARNING
<p>Improper use of the unit can result in serious or even fatal injuries!</p> <p>Have you read the safety precautions in Chapter 1, "Safety", Pg. 3 f.?</p> <p>Otherwise you may not carry out any work with or on the pump-motor unit!</p>

⚠ WARNING
<p>Improper use of the unit can result in serious or even fatal injuries!</p> <p>All maintenance work on the pump-motor unit must always be performed by the Service Department!</p> <p>Maintenance work on the pump-motor unit may only be conducted by the operator itself when the related maintenance manual on hand!</p> <p>Inquire with the Service Department!</p>

Fault	Cause	Remedy	Carried out by
	Impeller defective.	Replace impeller.	Service ^{*)}
	Rolling bearing on drive motor side or vacuum pump/compressor side defective.	Replace motor bearing or vacuum pump/compressor bearing.	Service ^{*)}
Protective motor switch trips when motor is switched on. Power consumption too high.	Winding short-circuit.	Have winding checked.	Electrician
	Motor overloaded. Throttling does not match specification on rating plate.	Reduce throttling.	Service ^{*)}
		Clean filters, mufflers and connection pipes if necessary.	Service ^{*)}
	Compressor is jammed.	See fault: "Motor does not start; humming noise." with cause: "Impeller is jammed.".	Service ^{*)}
Pump-motor unit does not generate any or generates insufficient pressure difference.	Leak in system.	Seal leak in the system.	Operator
	Wrong direction of rotation.	Reverse direction of rotation by interchanging two connecting leads.	Electrician
	Incorrect frequency (on pump-motor units with frequency converter).	Correct frequency.	Electrician
	Shaft seal defective.	Replace shaft seal.	Service ^{*)}
	Different density of pumped gas.	Take conversion of pressure values into account. Inquire with Service Department.	Service
	Change in blade profile due to soiling.	Clean impeller, check for wear and replace if necessary.	Service ^{*)}
Abnormal flow noises.	Flow speed too high.	Clean pipes. Use pipe with larger cross-section if necessary.	Operator
	Muffler soiled.	Clean muffler inserts, check condition and replace if necessary.	Service ^{*)}
Abnormal running noise.	Ball bearing lacking grease or defective.	Regrease or replace ball bearing.	Service ^{*)}
Compressor leaky.	Seals on muffler defective.	Check muffler seals and replace if necessary.	Service ^{*)}
	Seals in motor area defective.	Check motor seals and replace if necessary.	Service

^{*)} Only when the maintenance manual is at hand: rectification by the operator.

9.2 Service/After-sales service

Our Service is available for work (in particular the installation of spare parts, as well as maintenance and repair work), not described in these operating instruction.

A list of spare parts with an exploded drawing is available on the Internet at www.nash-elmo.com.

Observe the following when **returning** pump-motor unit:

- The pump-motor unit must be delivered complete, i.e. not dismantled.
- The pump-motor unit may not present a danger to the workshop personnel. If the pump-motor unit has come into contact with dangerous substances, then the procedure described in Chapter 9.3, "Decontamination and Declaration of Clearance", Pg. 24, must be used.
- The original rating plate of the pump-motor unit must be properly mounted, intact and legible. All warranty claims are voided for pump-motor units delivered for a damage expertise without the original rating plate or with a destroyed original rating plate.
- In case of warranty claims, the manufacturer must be informed of the operating conditions, operating duration etc. and additional detailed information provided on request if necessary.

9.3 Decontamination and Declaration of Clearance

 WARNING
Danger from flammable, caustic or toxic substances! To protect the environment and persons, the following applies: Pump-motor unit which have come into contact with dangerous substances must always be decontaminated before being passed on to a workshop!

To provide proof that the decontamination was carried out, a so-called **declaration of clearance** must be included with the pump-motor unit on delivery to the workshop. The form required for this purpose is available from the Service Department.

10 Disposal

Have the entire pump-motor unit scrapped by a suitable disposal company. No special measures are required when doing so. For additional information on disposing of the unit, ask the Service Department.

11 Explosion-Protected Design

An additional set of operating instructions with supplementary or specific information is provided with these pump-motor units.

12 Declaration of Conformity



EC Declaration of Conformity

Manufacturer: nash_elmo Industries GmbH
Postfach 1510
D-97605 Bad Neustadt / Saale

Product designation: Gas-Ring Vacuum Pumps/Compressors of the G_200 Series,
Types 2BH1 1.., 2BH1 2.., 2BH1 3.., 2BH1 4.., 2BH1 5.., 2BH1 6.., 2BH1 8..,
2BH1 9..

The designated product complies with the provisions of the following European Directives:

98/37/EC	Machinery Directive
73/23/EEC	Low Voltage Directive
89/336/EEC*)	EMC Directive

The conformity with these Directives is proven by complete adherence to the following standards:

Harmonized standards:

DIN EN 292-1	Safety of machinery; Basic concepts, general principles for design; Part 1: Basic terminology, methodology
DIN EN 292-2	Safety of machinery; Basic concepts, general principles for design; Part 2: Technical principles and specifications
DIN EN 294	Safety of machinery; Safety distances to prevent danger zones from being reached by the upper limbs
DIN EN 563	Safety of machinery; Temperatures of touchable surfaces; Ergonomics data to establish temperature limit values for hot surfaces
DIN EN 626-1	Safety of machinery; Reduction of risk to health from hazardous substances emitted by machinery; Part 1: Principles and specifications for machinery manufacturers
DIN EN 1012-1	Compressors and vacuum pumps; Safety requirements; Part 1: Compressors
DIN EN 1012-2	Compressors and vacuum pumps; Safety requirements; Part 2: Vacuum pumps
EN ISO 11688-1	Acoustics; Recommended practice for the design of low-noise machinery and equipment ; Part 1: Planning (ISO/TR 11688-1:1995)
DIN EN 60034	Rotating electrical machines
DIN EN 60146-1-1*)	Semiconductor converters; General requirements and line commutated converters
DIN EN 60204-1	Safety of machinery; Electrical equipment of machines; Part 1: General requirements (IEC 204-1:1992, modified)
DIN EN 61000-6-2*)	Electromagnetic compatibility (EMC); Part 6-2: Generic emission standard: Interference immunity for industrial applications (IEC 61000-6-2:1999, modified); German version EN 61000-6-2:2001
DIN EN 61000-6-4*)	Electromagnetic compatibility (EMC); Part 6-4: Generic emission standards: Basic specification on emitted interference for industrial applications (IEC 61000-6-4:1997, modified); German version EN 61000-6-4:2001

The machine's operating instructions are available in German (original version) and in English. The technical construction file is available in German (original version). Any modifications of the machine that have not beforehand been agreed upon and permitted by us in writing invalidate this Declaration of Conformity.

nash_elmo Industries GmbH
Bad Neustadt / Saale, 09/10/2002

(Erich Michael Wenzel, Management)

(Dr. Uwe Seidel, Director of Development)

*) Only applicable for design with (mounted or unmounted) frequency converter.