

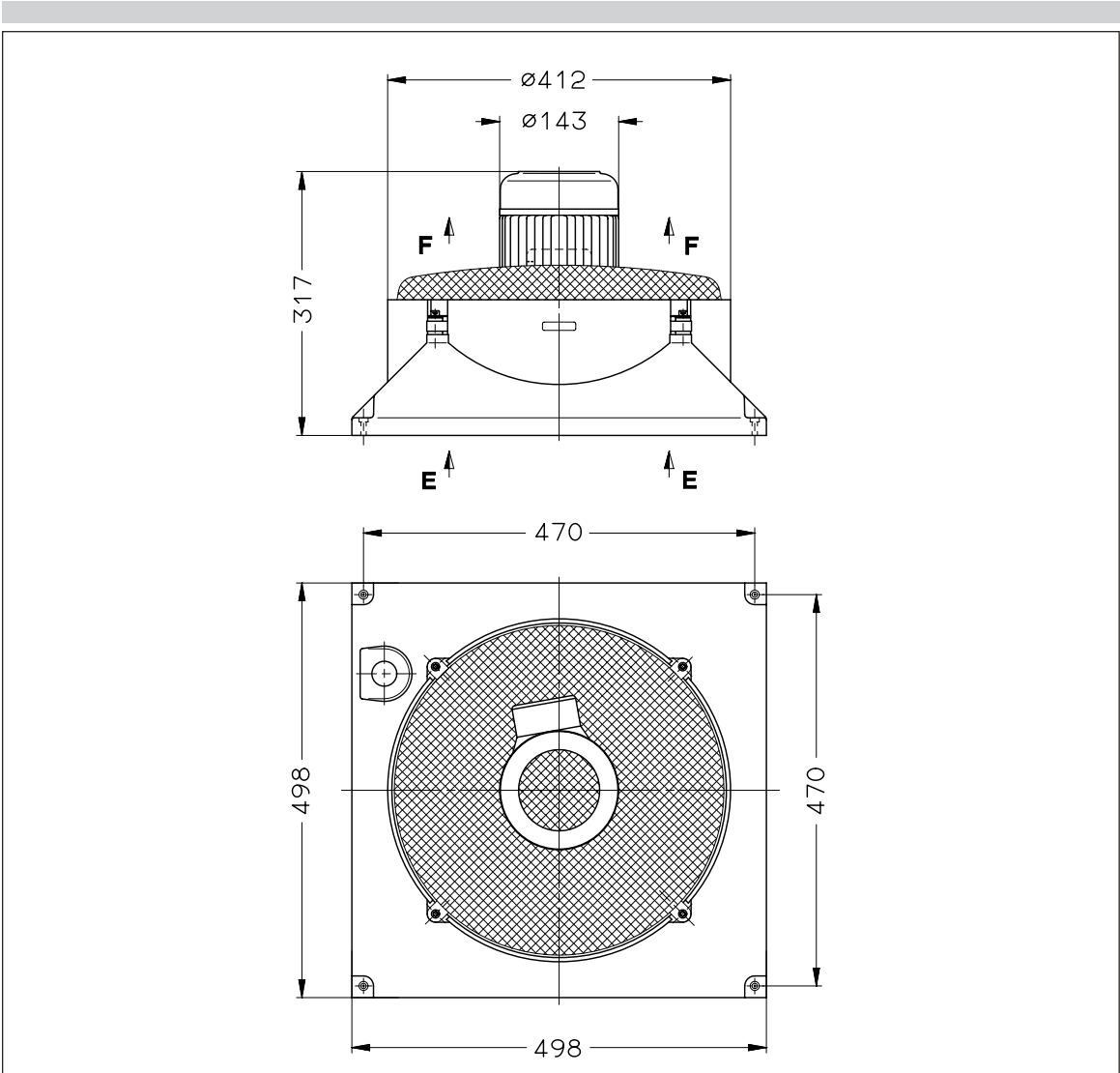

Zubehör Accessories Accessoires Accessori



Ident-Nr. 318125-0000

[mm]

E	Dachlüfter	Roof fan	Ventilateur toit	Ventilatore tetto
F	Kühlluft-Eintritt	Cooling air entry	Entrée air refroidissement	Entrata aria di raffreddam.
m³/h	Kühlluft-Austritt	Cooling air exit	Sortie air refroidissement	Uscita aria di raffreddam.
kW	Kühlluftmenge	Cooling air capacity	Volume air refroidissement	Portata aria di raffreddam.
A	Motorleistung	Motor rating	Puissance moteur	Potenza motore
	Stromaufnahme	Current drawn	Intensité absorbée	Corrente nominale

	50 Hz	60 Hz
m³/h	3800	4500
3 ~	230/400V ±10%	
kW	0,37	0,45
A	1,25 / 2,20	1,20 / 2,10

Motorausführung	→ Isolierstoffklasse F	Schutzart IP 54	Bauform IM B 14
Motor version	→ Insulation class F	Protection class IP 54	Mounting IM B 14
Exécution moteur	→ Class d'isolation F	Degré de protection IP 54	Formes de construction IM B 14
Esecuzione motore	→ Classe di isolamento F	Classe di protezione IP 54	Forma costruttiva IM B 14

Z 14/1

1.6.95

Werner Rietschle GmbH + Co. KG
 Postfach 1260
 D-79642 Schopfheim
 ☎ 07622/392-0
 Fax 07622/392300
 e-mail: info@rietschle.com
 http://www.rietschle.com